



**SALES
PROMOTION &
PRESENTATION
SOLUTIONS**

Tobacco & NGP

GENERAL CATALOG - EN



Presentation solutions for

RMC

READY MADE CIGARETTES

PRESENTATION SOLUTIONS FOR RMC AT A GLANCE



Doubling the facings
on the same shelf with
the POS-T Duplex Pushfeed



100% brand focus
- horizontal presentation with the
POS-T SloMo Pushfeed System



One system – many options
with maximum filling capacity
with POS-T Duplex XL



Space and cost efficient
RMC presentation
with POS-T Duplex XL for RMC



READY MADE CIGARETTES RMC ARE CHANGING

TIME TO TAKE ACTION!

The cigarette and tobacco market is changing. Next generation products are advancing. Chewing tobacco and e-cigarettes in a liquid or cap system have been brought onto the market and advertised as successors to classic cigarettes. Nevertheless, experts estimate that there will continue to be a market for classic RMC products up to the year 2050. Cigarettes are still in a good position - on the shelf, that is to say. Next generation products then share the sparse space in the front of the counter area with chocolate bars and lottery tickets. It won't always be so! The competition for sought-after space on the tobacco shelf has begun. Don't let it get out of hand - there is enough space for everyone!

Using a horizontal, stacked presentation in the new POS-T Duplex Pushfeed, you can double your product facings on your current shelf.

OVERVIEW OF THE NUMBERS

+ 50% more product facings on the shelf using the same number of shelves thanks to the new POS-T Duplex Pushfeed

+ 100% Better visibility of your brand with the perfect focus - even if the products vary in size and type

THE EXPERTS AT THE POINT OF SALE!

We are your global partner when it comes to selling tobacco goods. Regardless of whether you are selling king-size, big or small packs, round chewing tobacco tins or modern e-cigarettes in a cap or liquid system. And regardless of whether the presentation is horizontal or vertical - all products are staged optimally. Furthermore, we have all the answers to the problems of the future - changing legal requirements and the reduction of available shelf space. We have many years of experience, meaning we are reliable specialists in your market segment.



THE PROBLEM

Classic cigarettes are in close competition with next generation products at the point of sale.

Sales areas are becoming increasingly smaller, compelling companies to rethink strategy.

Warning messages are making it harder to focus on the brand.

It is now impossible to get a good overview thanks to the increasing variety of packaging sizes.



THE PERFECT SOLUTION

Horizontal presentation with an additional level creates more space on the existing shelf.



THE RESULT

Double the space for products on the shelf

More space for new generation products

Improved visibility thanks to the tidier shelf appearance

Content

Duplex presentation (upright)	Page	18	-	20
Duplex presentation (lying)	Page	21	-	24
Duplex presentation (individual)	Page	25	-	28
lying presentation	Page	29	-	29
upright presentation	Page	30	-	31

RMC

Duplex presentation (upright)



POS-T Duplex XL RMC Set

The next revolutionary step in cigarette shelving

With the new POS-T Duplex XL system, specially developed for upright cigarettes, you not only save on expensive shelves, but also achieve up to 20% more storage space with the same shelf area.

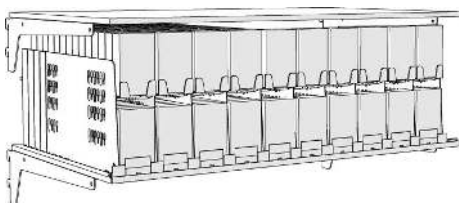

POS-T Duplex XL for a double-level presentation

Set for 20 facings consists of the following components:

- 11 x Duplex XL Divider
- 40 x Clip-on for POS-T Duplex XL Divider
- 10 x Pushfeeds for upper level
- 10 x Pushfeeds for bottom level

Required shelf distance: 210mm. Continuously width flexible 56 - 76mm.

No. of Facings	Depth mm	PU	Item No.
20	265	1	30009526
20	375	1	30009475

Other depths and versions on request.

RMC

Duplex presentation (upright)

POS-T Duplex XL RMC Components

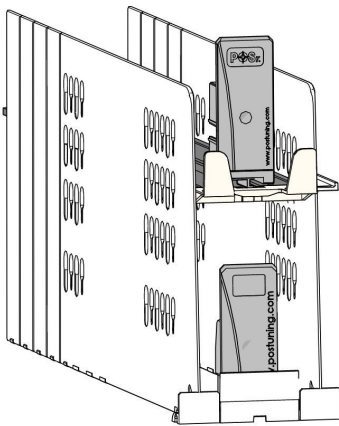

POS-T Duplex XL System for RMC is the effective and affordable solution to **increase your shelf capacity and reduce shelves.**

With a Duplex presentation you do without every 2nd shelf, instead you present your products twice on top of each other. The optimized height settings in the Duplex XL shelf divider allow you to optimize shelf spacing and gain up to 20% additional shelf space.

Suitable for packages up to 76mm wide
Required shelf distance: 210mm

The following components are required for the double placement of your RMC products:

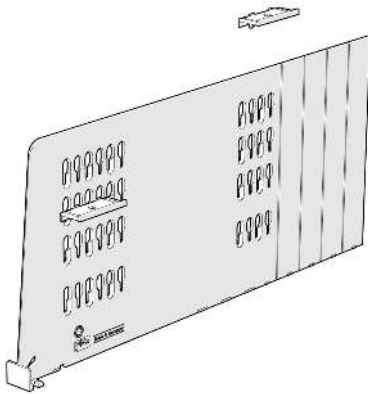

Divider Duplex XL, with front fixation, height 160mm, transparent, vario

- Divider height 160mm
- Breakable Divider from 255 - 355mm
- With front stop 15mm

Length mm	Height mm	PU	Item No.
255	160	1	30009491
255-355	160	1	30009469

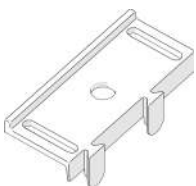

Clip-on for POS-T Duplex XL Divider

- For installing width flexible pushfeed levels (56 - 76mm)
- For individual installation options
- Attached in seconds - transformed in seconds

4 clips are needed for one level.

PU	Item No.
1	30008706

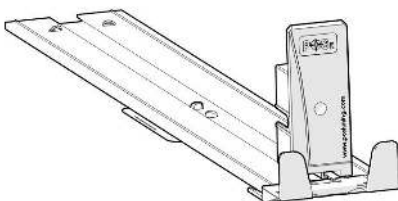

POS-T Duplex XL Pushfeed for RMC

Pushfeed System for the upper duplex level. With Pushfeed width 28mm, height 70mm, depth 25mm and frontstop 20mm. With pre-installed F005 guiderail.

Length mm	PU	Item No.
310	1	30009474
375	1	30009471

RMC

Duplex presentation (upright)

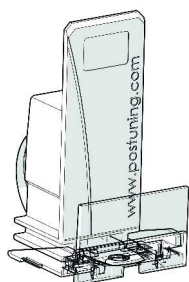

Pushfeed with 25mm front stop, width 28mm, height 70mm, light gray

With front anchor W 39 x H 25mm.

Max. capacity mm	Force Newton	PU	Item No.
415	2	1	30009052

RMC

Duplex presentation (lying)

Planogram example

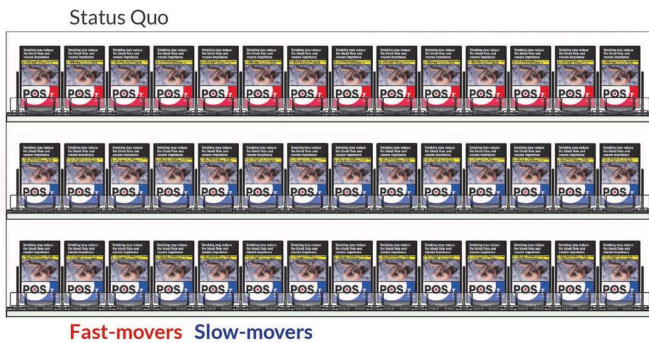

+ 33% more shelf space

with the POS-T Duplex Pusher

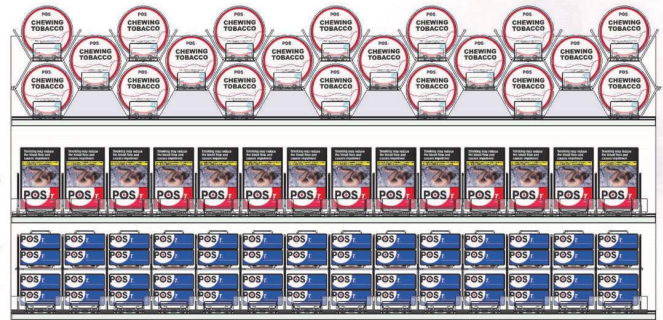

POS-T Duplex Set

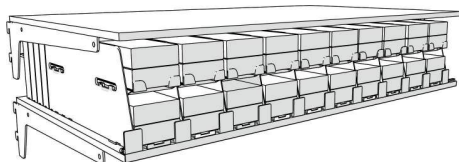
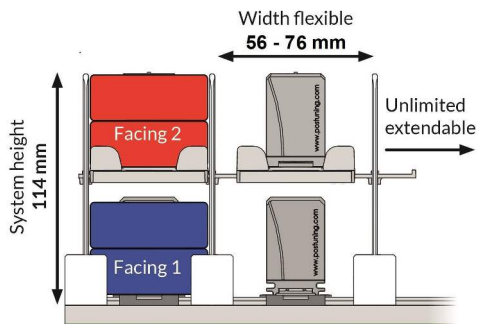

The new way of cigarette presentation

With the POS-T Duplex Pusher from POS TUNING you can double your cigarette facings without increasing shelf space. This creates space for Next Generation Products on your shelf - without reducing the RMC product range.

- For all product widths from Kingsize to Big Packs
- For all product heights up to 26mm
- No change of existing shelving systems necessary
- NGP - Displays in the counter area can be reduced

POS-T Duplex Pusher for a double-level presentation

Set for 20 facings consists of the following components:

- 11 x Divider
- 10 x middle shelves
- 20 x SloMotion Pushfeeds

For product widths from 56-76mm.

No. of Facings	Depth mm	Max. filling quantity	PU	Item No.
20	310	6 x 20 packs	1	30006906
20	395	8 x 20 packs	1	30006847

Other depths and versions on request.

RMC

Duplex presentation (lying)

POS-T Duplex components

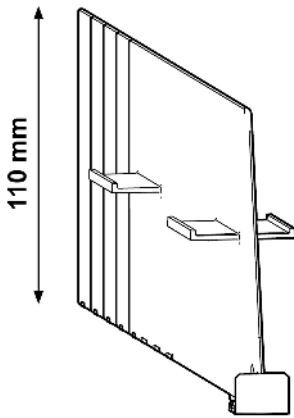

Divider Duplex D110, with front fixation, height 110mm, transparent

Middle Divider of a Duplex series.

With variable lengths, can be individually adjusted within 25mm grid. For flexible use of articles with different shelf depths. Front fixation 15mm high.

Divider #30007958 already shortened

Length mm	Height mm	PU	Item No.
255-305	110	22	30007958
255-355	110	26	30007641

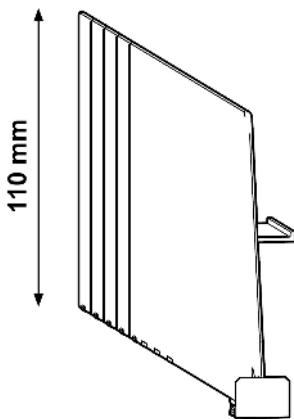

Divider Duplex D110, with front fixation, height 110mm, transparent

Divider for left end of a Duplex series.

With variable lengths, can be individually adjusted within 25mm grid. For flexible use of articles with different shelf depths. Front fixation 15mm high.

Divider #30007957 already shortened

Length mm	Height mm	PU	Item No.
255-305	110	40	30007957
255-355	110	26	30007643

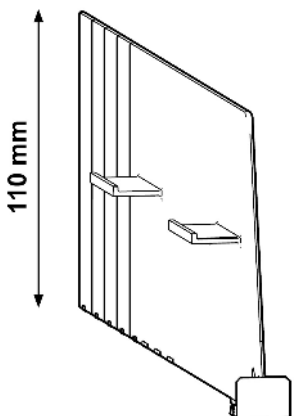

Divider Duplex D110, with front fixation, height 110mm, transparent

Divider for right end of a Duplex series.

With variable lengths, can be individually adjusted within 25mm grid. For flexible use of articles with different shelf depths. Front fixation 15mm high.

Divider #30007959 already shortened

Length mm	Height mm	PU	Item No.
255-305	110	40	30007959
255-355	110	26	30007644

RMC

Duplex presentation (lying)

SlowMotion Duplex Pushfeed

Pushfeed System for the upper duplex levels.
With pre-installed F005 guiderail.

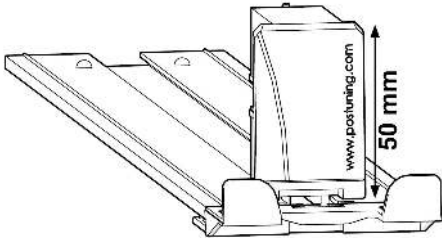

Length mm	Max. filling quantity	PU	Item No.
310	6 packs	1	30007354
393	8 packs	1	30007352

SlowMotion Duplex Pushfeed

Pushfeed System for the lower duplex level.
With pre-installed F003 guiderail.

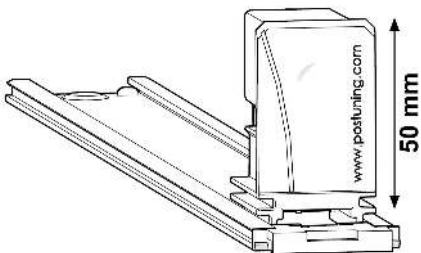

Length mm	Max. filling quantity	PU	Item No.
310	6 packs	1	30007353
393	8 packs	1	30007350

RMC

Duplex presentation (lying)

Communication POS-T Duplex

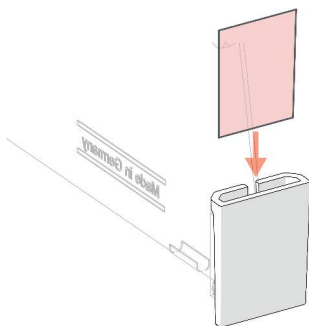

Divider clips for orientation labels

Orientation is that simple!

Simply put it on the divider and each facing has its own labelholder for an individual orientation hint.

For labels: W 17 x H 26mm

We recommend paper from 160g.

One set contains 25 divider clips.

PU	Item No.
1	30007359

RMC

Duplex presentation (individual)

One System – many Options

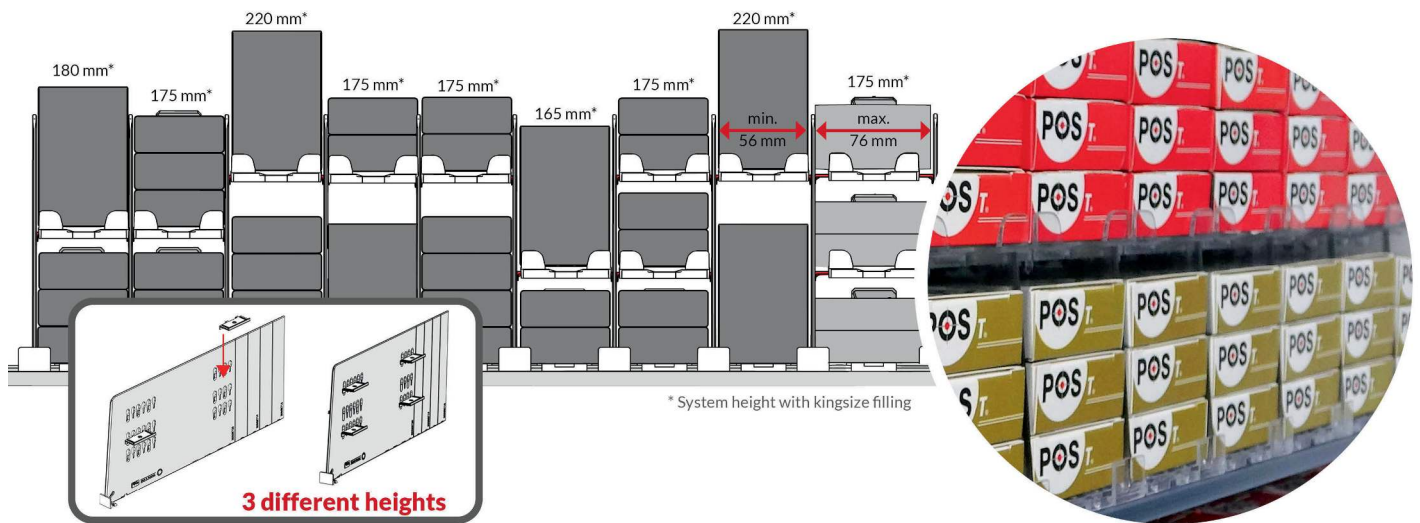

POS-T Duplex XL Set

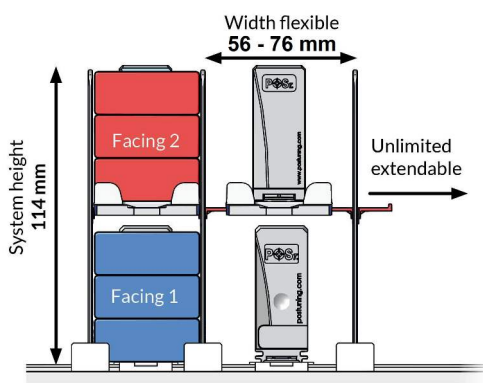

POS-T Duplex XL

One system - many options

Opportunities and benefits at a glance:

- Many presentation options with one system
- Full packing units in one facing
- 100% compatible with other POS-T Pushfeeds
- Simple „one-click“ installation from the shelf front
- 3 different heights adjustable
- Continuously width flexible (56 - 76mm)

Creates space for more products on the shelf

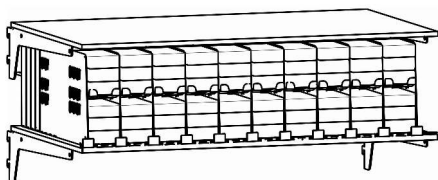

POS-T Duplex XL for a double-level presentation

Set for 20 facings consists of the following components:

- 11 x Duplex XL Divider
- 40 x Clip-on for POS-T Duplex XL Divider
- 10 x SlowMotion Pushfeeds for upper level
- 10 x SlowMotion Pushfeeds for bottom level

No. of Facings	Depth mm	PU	Item No.
20	310	1	30009111
20	394	1	30009105

Other depths and versions on request.

RMC

Duplex presentation (individual)

POS-T Duplex XL Divider

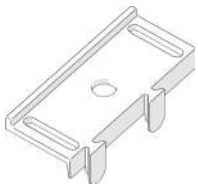
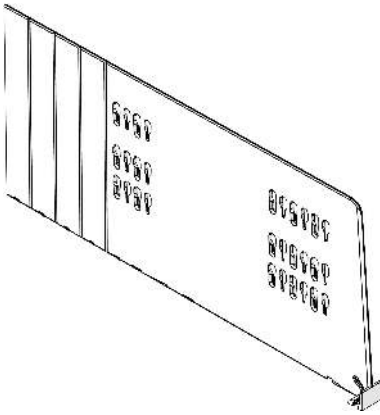

Divider Duplex XL, with front fixation, height 160mm, transparent, vario

- Divider height 160mm
- Breakable Divider from 255 - 355mm
- With front stop 15mm

Length mm	Height mm	PU	Item No.
255-305	160	1	30008719
255-355	160	1	30008713

Clip-on for POS-T Duplex XL Divider

- For installing width flexible pushfeed levels (56 - 76mm)
- For individual installation options
- Attached in seconds - transformed in seconds

4 clips are needed for one level.

PU	Item No.
1	30008706

POS-T Duplex XL | 2 Pushfeed Level

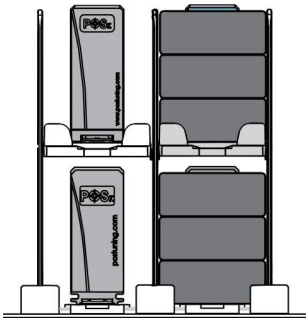

With a Duplex XL double presentation of your RMC products you have many advantages:

- Maximum filling capacity with low space requirement
- 2 full packaging units fit into one double facing
- Reduction of required shelves saves costs
- Reduction of shelf distances creates space for new products
- Premium look through stacked presentation

SlowMotion Duplex XL Pushfeed

Pushfeed System for the upper duplex level.
With pre-installed F005 guiderail.

Length mm	Max. filling quantity	PU	Item No.
310	9 packs	1	30009103
393	12 packs	1	30009101

RMC

Duplex presentation (individual)

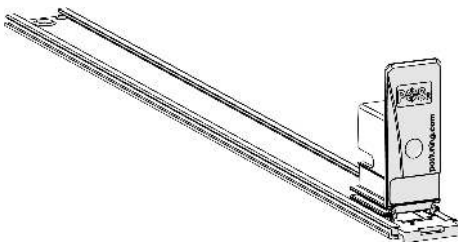

SlowMotion Duplex XL Pushfeed

Pushfeed System for the upper duplex level.
With pre-installed F005 guiderail.

Length mm	Max. filling quantity	PU	Item No.
310	9 packs	1	30009104
393	12 packs	1	30009102

POS-T Duplex XL | 3 Pushfeed Level

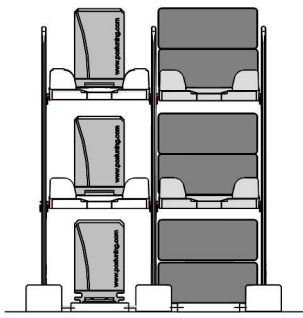

Turn the Duplex into a Triplex!

With a Duplex XL Triple presentation of your RMC products you have many advantages:

- Maximum filling capacity with low space requirement
- Reduction of required shelves saves costs
- Reduction of shelf distances creates space for new products
- Premium look through stacked presentation

SlowMotion Duplex Pushfeed

Pushfeed System for the upper duplex levels.
With pre-installed F005 guiderail.

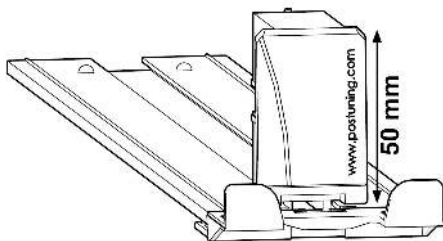

Length mm	Max. filling quantity	PU	Item No.
310	6 packs	1	30007354
393	8 packs	1	30007352

SlowMotion Duplex Pushfeed

Pushfeed System for the lower duplex level.
With pre-installed F003 guiderail.

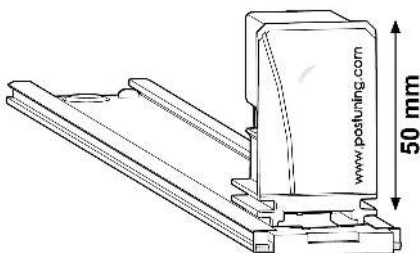

Length mm	Max. filling quantity	PU	Item No.
310	6 packs	1	30007353
393	8 packs	1	30007350

RMC

Duplex presentation (individual)

Communication

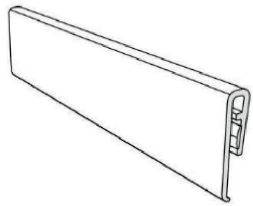
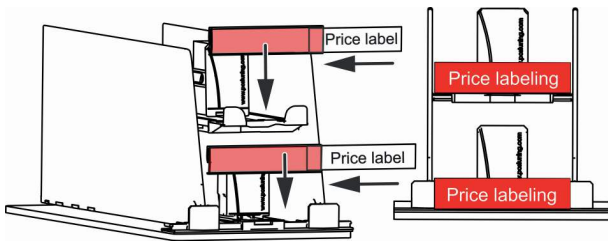

POS-T Duplex Labelholder for pricing

Attachment for paper labels, e.g. price labelling or brand communication.

For label height 15mm. Recommended paper thickness 140 - 180g.

Labelholder for upper levels compatible with all facing widths. Labelholder for lower level only compatible with facing widths 56 - 65mm.

Length mm	Height mm	PU	Item No.
55	17	1	30009116

POS-T Duplex Labelholder E028 for pushfeeds, width 30mm

Compatible with pushfeed with width 28mm, with insert for labels width 28mm.

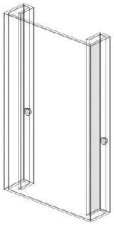

Height mm	Width mm	PU	Item No.
37	30	1	30009114
63	30	1	30009115

Divider clips for orientation labels

Orientation is that simple!

Simply put it on the divider and each facing has its own labelholder for an individual orientation hint.

For labels: W 17 x H 26mm

We recommend paper from 160g.

One set contains 25 divider clips.

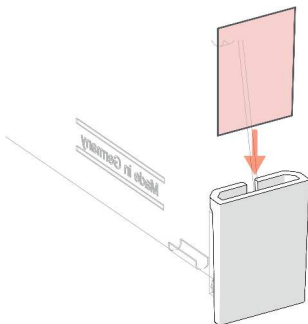

PU	Item No.
1	30007359

RMC

lying presentation



Show your products from their best side

Due to a horizontal presentation, the visibility is exclusively on the brand.

Perfect handling through controlled slow forward movement with SloMo Pushfeed.

For this presentation you need in addition to the pushfeed:

- Adapter-T Rail
- Guiderail, width 34mm
- Divider, height 100 or 12mm

These are described in the chapter **system components**.

King Size and Big Packs

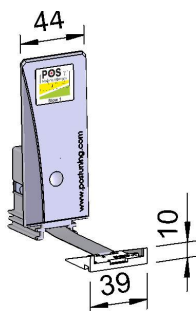

For product widths over 54mm.

Pushfeed with damper, width 44mm, height 110mm, depth 40mm, light gray

Damped pushfeed with universal strength for all stacked tobacco and NGP products from 54mm width. Without front stop, products stop at the dividers. Front gap 22mm.

Max. capacity mm	PU	Item No.
540	100	30004409

RMC

upright presentation



Perfect standing and easy removal of cigarette packs.

For this presentation you need in addition to the pushfeed:

- Adapter-T Rail
- Divider, height 60mm

These are described in the chapter system components.

King Size and Big Packs

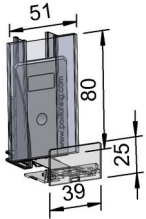

For product widths over 54mm.

Pushfeed with 25mm front stop and labelholder, width 51mm, height 80mm, depth 25mm, light gray

Labelholder for place reservation system. For labels W 49 x H 80mm. Front gap 22mm.

Max. capacity mm	Force Newton	PU	Item No.
390	2	120	30004498

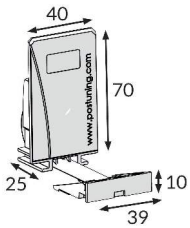

Pushfeed, width 40mm, height 70mm, depth 25mm, light gray

With front anchor W 39 x H 10mm, without own front stop. Products stop at the divider front stop. Front gap 22mm.

Max. capacity mm	Force Newton	PU	Item No.
390	2	140	30004499



Pushfeed with 25mm front stop, width 40mm, height 70mm, depth 25mm, light gray

With POS-T Newton label 2N. Front gap 22mm.

Max. capacity mm	Force Newton	PU	Item No.
390	2	140	30004503

RMC

upright presentation

Slim Packs

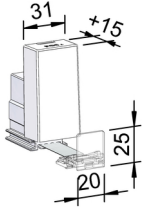

For product widths over 36mm.

Pushfeed with spacer, width 28mm, height 70mm, depth 40mm, light gray

Spacer 31 x 62 x 19mm decreases the **front gap to 5mm**, such that the last package of slim products stays safely in the pushfeed. With front stop W 20 x H 25mm. **For all products from 36mm width.**

Max. capacity mm	Force Newton	PU	Item No.
390	2	90	30004352

Ultra Slims

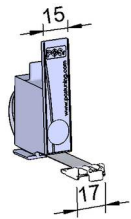

For product widths less than 36mm.

Pushfeed, width 15mm, height 68mm, light gray

With front anchor W 17 x H 5mm, without front stop.

Max. capacity mm	Force Newton	PU	Item No.
340	1.5	203	30004446

Accessories

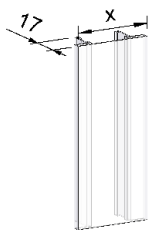

Labelholder E049, transparent

Compatible with pushfeed with width 28, 40 and 44mm, with insert for labels (W 49 x H 80mm).

Height mm	Width mm	PU	Item No.
80	51	60	30005521



Presentation solutions for

OTP

OTHER TOBACCO PRODUCTS

PRESENTATION SOLUTIONS FOR OTP AT A GLANCE



Custom-made

- Roll-your-own tobacco in pouches are served particularly well!



Finding space on the shelf

- We have the right pushfeed system for all sizes of cigarillos.



As for tins

- Square and round tins should also be kept in the front row!

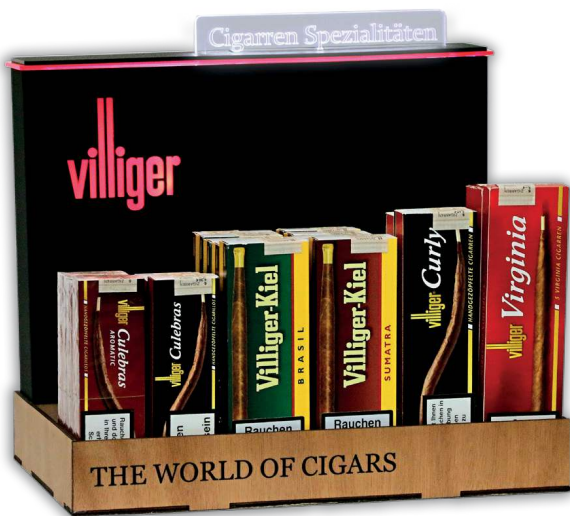

Presented according to size

- Perfect staging with individualised display solutions



TOBACCO, CIGARS & CIGARILLOS – OTP BELONG AT THE FRONT!

DIVERSITY IS NOT COMPLICATED

Other Tobacco Products – the umbrella term for everything else sold in the tobacco industry. Cigarillos, tobacco pouches, square and round tins, buckets, zip-bags and even papers and sleeves.

More simply, OTPs are diverse. Goods presentation at the point-of-sale should be just as diverse. However, diversity is not automatically more complicated – with only a few different POS-T Pushfeed Systems, you can perfect the presentation of OTPs at the point-of-sale. And this is more important than ever. Thanks to increasing cigarette prices, OTPs have gained importance over the past few years. Rolling your own is now trendy. Therefore, it would be a pity if tins, buckets and papers were left in the background. They don't belong back there.

Just as important: Displays and secondary placements offer the basis for additional turnover or successful product launches and showcase the value of products – this applies to the counter and the shelf.

OVERVIEW OF THE NUMBERS

120 countries have made use of our goods pushfeed systems so far.

5 various POS-T pusher systems cover the complete OTP category.

THE EXPERTS AT THE POINT OF SALE!

We are your global partner when it comes to selling tobacco goods. Regardless of whether you are selling king-size, big or small packs, round chewing tobacco tins or modern e-cigarettes in a cap or liquid system. And regardless of whether the presentation is horizontal or vertical – all products are staged optimally. Furthermore, we have all the answers to the problems of the future – changing legal requirements and the reduction of available shelf space. We have many years of experience, meaning we are reliable specialists in your market segment.



THE CATEGORY PROBLEMS

Many different packaging sizes and shapes make presentation more difficult.

Many promotional products and trial offers in small packages.

Thanks to increasing cigarette prices, make-your-own products are gaining popularity.



THE PERFECT SOLUTION

Our POS-T Pushfeed Systems with dividers ensure the permanent presentation of – all products



THE RESULT

Better visibility of products

Easy to take products out

Improved focus thanks to the tidier shelf appearance

Optimal use of space

More sales

Content

Roll-Your-Own (RYO)	Page	38	-	39
Cigarillos and cigars	Page	40	-	41
Make-Your-Own (MYO)	Page	42	-	44
Sisha	Page	45	-	46

OTP

Roll-Your-Own (RYO)



Pouches, landscape style

Presentation Solution for RYO-products, fitting all standard shelves. Great stability and optimal visibility of the products, for small and slim packaging.

The **rounded front anchor** improves the product presentation and is gentle on your pouches.

For this presentation you need in addition to the pushfeed:

- Adapter-T Rail
- Guiderail, width 34mm
- Divider, height 60mm

These are described in the chapter **system components**.

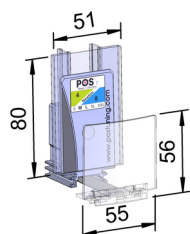

Pushfeed with 56mm front stop and labelholder, width 51mm, height 80mm, depth 35mm, light gray

With rounded front anchor W 55 x H 56mm for portrait and soft packaging. Labelholder for labels W 49 x H 80mm.

Max. capacity mm	Force Newton	PU	Item No.
560	4-8	60	30004528

Pouches, portrait style

For the horizontal presentation of pouches you need in addition to the pushfeed:

- Adapter-T Rail
- Guiderail, width 34mm
- Divider, height 60mm

These are described in the chapter **system components**.



Pushfeed with 35mm front stop, width 40mm, height 75mm, depth 35mm, light gray

With front anchor W 39 x H 35mm, front gap 22mm.

Max. capacity mm	Force Newton	PU	Item No.
560	4-8	100	30004531

OTP

Roll-Your-Own (RYO)

Papers

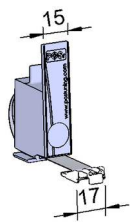

For the presentation of papers you need in addition to the pushfeed:

- Adapter-T Rail
- Guiderail, width 19mm
- Divider, height 35mm with high front stop

These are described in the chapter **system components**.

Pushfeed, width 15mm, height 68mm, light gray

With front anchor W 17 x H 5mm, without front stop.

Max. capacity mm	Force Newton	PU	Item No.
340	1.5	203	30004446

OTP

Cigarillos and cigars

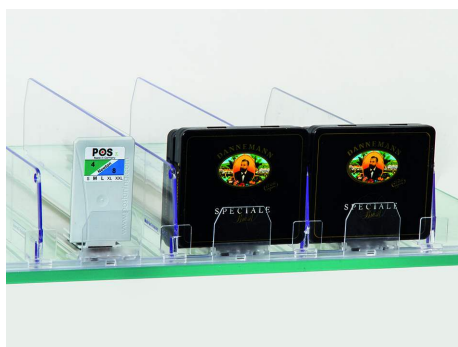

Presentation solutions for cigars and cigarillo. stable presentation, with Pushfeeds and dividers.

Cigarillos, large packages

For the presentation of cigarillos with a width from 54mm you need in addition to the pushfeed:

- Adapter-T Rail
- Guiderail, width 34mm
- Divider, height 60mm

These are described in the chapter **system components**.

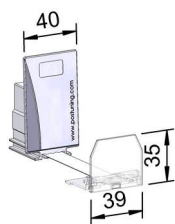

Pushfeed with 35mm front stop, width 40mm, height 70mm, depth 25mm, light gray

Max. capacity mm	Force Newton	PU	Item No.
560	4-8	100	30006932



Labelholder E049, transparent

Compatible with pushfeed with width 28, 40 and 44mm, with insert for labels (W 49 x H 80mm).

Height mm	Width mm	PU	Item No.
80	51	60	30005521

OTP

Cigarillos and cigars

Cigars

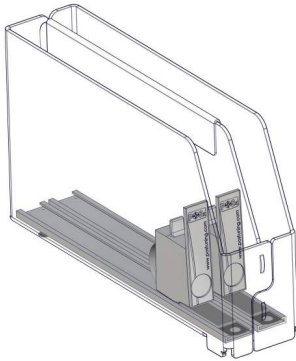

Cigar Tube Presenter, transparent

With 2 facings consisting of divider and pushfeed. To clip on Adapter-T Rail.

Dimensions WxDxH mm	No. of Facings	PU	Item No.
52x210x125	2	3	30001424

Other measurements upon request.

Cigarillos, narrow packages

For the presentation of cigarillos with a width from 36mm you need in addition to the pushfeed:

- Adapter-T Rail
- Guiderail, width 34mm
- Divider, height 60mm

These are described in the chapter **system components**.

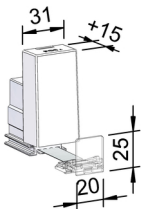

Pushfeed with spacer, width 28mm, height 70mm, depth 40mm, light gray

Spacer 31 x 62 x 19mm decreases the **front gap to 5mm**, such that the last package of slim products stays safely in the pushfeed. With front stop W 20 x H 25mm. **For all products from 36mm width.**

Max. capacity mm	Force Newton	PU	Item No.
390	2	90	30004352

OTP

Make-Your-Own (MYO)

Presentation solution for MYO products, suitable for all standard shelf systems. Upright, secured position, more stability and optimum visibility for round and large packages.

Tins



For the presentation of MYO-Tins you need in addition to the pushfeed:

- Adapter-T Rail
- Guiderail, width 34mm
- Divider, height 60mm

These are described in the chapter **system components**.

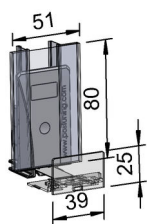

Pushfeed with 25mm front stop and labelholder, width 51mm, height 80mm, depth 25mm, light gray

Labelholder for place reservation system. For labels W 49 x H 80mm. Front gap 22mm.

Max. capacity mm	Force Newton	PU	Item No.
390	2	120	30004498



Tobacco Tins

Presenter for tobacco tins, 2 facings for 3 tins,

consisting of:

- 1 x Presenter, transparent, inclined
- 3 x Guiderails
- 2 x Rubber feets

No. of Facings	Depth mm	Width mm	PU	Item No.
2	316	214	1	30001386
3	316	318	1	30001387

Other measurements upon request.

Zip-Bags



Tobacco Zipbag Presenter for 145g packs, transparent

Presenter for tobacco pouches, 145g.

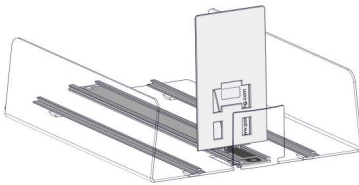

Height mm	Depth mm	Width mm	PU	Item No.
140	332	229	28	30001459

Other measurements upon request.

OTP

Make-Your-Own (MYO)

Gravity solution for MYO

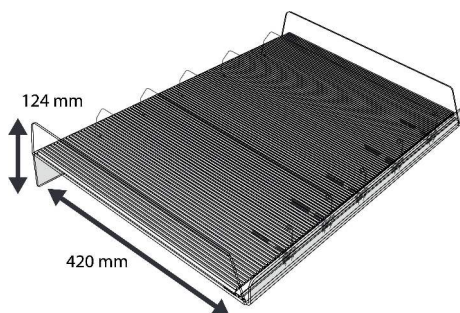

MYO sliding shelf with VARUS

Frontfacing by gravity

The special feature of POS-T VARUS gliding profiles ensures that buckets, cans and other MYO products slide to the front of the shelf even at a glide inclination. The special construction allows an overhang of 40mm - more cans, buckets and other MYO products can be presented one behind the other.

Designed for shelves with a depth of 380mm.

The set for a complete shelf consists of

- Tilt tray, transparent.
- POS-T VARUS gliding profiles
- POS-T Divider height 60mm

All lengths and widths on request.

Dimensions WxDxH mm	No. of Facings	Width mm	Item No.
645x420x124	6	645	30006942
995x420x124	8	995	30006944

OTP Sisha

Shisha in cartons

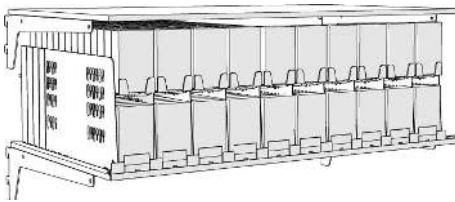

Flavoured shisha tobacco is becoming more and more popular. At the same time, the packaging of shisha tobacco is adapting more and more to the packaging of conventional cigarettes - and this is good for the presentation, because the products now also find space where they did not fit in before: on the tobacco shelf!

Depending on the system, dividers and adapter profiles are needed in addition to the pushfeed.

You can find many more presentation solutions and information in the chapter "RMC".

Pushfeed with 25mm front stop, width 40mm, height 70mm, depth 25mm, light gray

With POS-T Newton label 2N. Front gap 22mm.

Max. capacity mm	Force Newton	PU	Item No.
390	2	140	30004503

POS-T Duplex XL for a double-level presentation

Set for 20 facings consists of the following components:

- 11 x Duplex XL Divider
- 40 x Clip-on for POS-T Duplex XL Divider
- 10 x Pushfeeds for upper level
- 10 x Pushfeeds for bottom level

Required shelf distance: 210mm. Continuously width flexible 56 - 76mm.

No. of Facings	Depth mm	PU	Item No.
20	265	1	30009526
20	375	1	30009475

Other depths and versions on request.

Shisha Tins

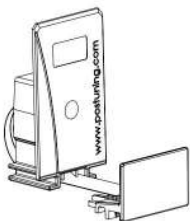

Pushfeed with 25mm front stop, width 40mm, height 70mm, depth 25mm, light gray

With front stop W 39 x H 25mm. Front gap 16mm.

Max. capacity mm	Force Newton	PU	Item No.
390	2	140	30004494

OTP

Sisha

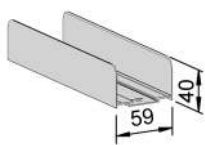

U-Channel F008, width 59mm, height 40mm, light gray

For product widths up to 56mm.

Length mm	Height mm	Width mm	Max. capacity mm	PU	Item No.
363	40	59	336	280	30003996

Other measurements upon request.

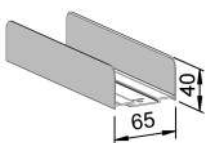

U-Channel F010, width 65mm, height 40mm, light gray

For product widths up to 62mm.

Length mm	Height mm	Width mm	Max. capacity mm	PU	Item No.
363	40	65	336	250	30003685

Other measurements upon request.

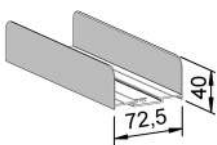

U-Channel F012, width 72mm, height 40mm, light gray

For product widths up to 69mm.

Length mm	Height mm	Width mm	Max. capacity mm	PU	Item No.
363	40	72	336	220	30003693

Other measurements upon request.



Presentation solutions for

NGP

NEXT GENERATION PRODUCTS

PRESENTATION SOLUTIONS FOR NGP AT A GLANCE



Tiny little crafty bees know how to construct something great – We do too! The new POS-T Honeycomb Channel for chewing tobacco



All nicotine levels on the board – are presented more elegantly. Only with the POS-T Mini SloMo.



Better from a bird's eye view – high stacks of caps are a highlight on the shelf.



Double the facings without additional shelf space using the POS-T Duplex Pushfeed.



For steam engines – the perfect presentation of your devices using the universal POS-T Pushfeed System.



Eye-catching e-shishas – as a display solution or for the shelf



THERE IS SPACE – NGP BELONGS ON THE SHELF!

INTERGENERATIONAL CONFLICT

A new generation of nicotine products is on the rise. Nicotine is now steamed, heated up and chewed. There is only one problem.

“Old” cigarettes are blocking the way for the new generation – their way onto the shelves. The space is already quite scarce. And classic cigarettes are still in an economically profitable place, so a reduction of the RMC range hasn't been considered. But is a confusing counter display the answer?

No! It's time for the younger generation to rebel. It's time to put the older generation to bed and make an entrance.

Using a horizontal presentation in the new POS-T Duplex Pushfeed, you can double your product facing on your current shelf thanks to an additional level – the perfect space for all slow-selling RMC!

OVERVIEW OF THE NUMBERS

+ 50% more products displayed on the shelf using the same number of shelves thanks to the new POS-T Duplex Pushfeed.

+ 100% You can cater to all tastes and nicotine levels on the same shelf if you change your product placement.

THE EXPERTS AT THE POINT OF SALE!

We are your global partner when it comes to selling tobacco goods. Regardless of whether you are selling king-size, big or small packs, round chewing tobacco tins or modern e-cigarettes in a cap or liquid system. And regardless of whether the presentation is horizontal or vertical – all products are staged optimally. Furthermore, we have all the answers to the problems of the future – changing legal requirements and the reduction of available shelf space. We have many years of experience, meaning we are reliable specialists in your market segment.



THE CATEGORY PROBLEMS

Current shelving systems are normally not extendible and are used for classic cigarettes.

Next generation products have no space on the shelf.

The result is a scrambled-looking counter display.

Next generation products are not acknowledged as their own category.

The threat of products being stolen in the till area is high.



THE PERFECT SOLUTION

With the POS-T Duplex Pushfeed, you can create space on the shelf without reducing the range.



THE RESULT

There is now space on the shelf for new NGPs.

NGPs are placed in their own category and posed as the centre of attention.

Shop-owners are prepared to incorporate more products into their range.

Content

Liquid Caps	Page	52	-	55
Liquid bottles	Page	56	-	57
Vapour equipment	Page	58	-	58
E-Shishas disposable	Page	59	-	61
Oral Tobacco tins	Page	62	-	66

NGP Liquid Caps

Caps, sideway presentation



A sideway presentation of Caps and Pods has many advantages. It offers space for all flavours with different nicotine strengths.

Our tip: For a clear orientation and brand message, present one flavour with the front facing forward. The other nicotine strengths can be presented lateral to save space.

For the sideway presentation caps and pods you need in addition to the pushfeed:

- Adapter-T Rail
- Guiderail, width 19mm
- Divider, height 60mm

These are described in the chapter **system components**.

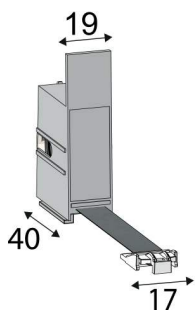

POS-T Mini SloMo, with damper, width 19mm, height 67mm, depth 40mm, light gray

With front anchor W 17 x H 5mm without front stop. Only with use of dividers.

Delay the advancement of very small and light products and thus prevents noise or tilting. For products from 19 to 45mm width. Also for stacked products.

Max. capacity mm	Force Newton	PU	Item No.
540	4	144	30006340

NGP

Liquid Caps

Caps, lying presentation

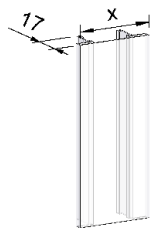
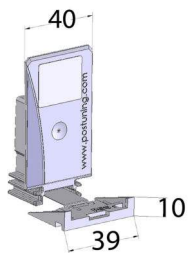

Optimal space utilization of your Liquid Caps and Pods.

With a lying presentation you can stack up to 5 packs on top of each other. Make full use of not only the depth, but also the height. Perfect handling through controlled slow forward movement with SloMo Pushfeed.

For the lying presentation of liquid caps and pods you need in addition to the pushfeed:

- Adapter-T Rail
- Guiderail, width 34mm
- Divider, height 60mm

These are described in the chapter **system components**.

Pushfeed with damper, width 40mm, height 75mm, depth 40mm, light gray

Damped pushfeed with universal strength for all stacked tobacco and NGP products from 54mm width. Without front stop, products stop at the dividers. Front gap 22mm.

Max. capacity mm	Force Newton	PU	Item No.
560	6	100	30006522

Labelholder E049, transparent

Compatible with pushfeed with width 28, 40 and 44mm, with insert for labels (W 49 x H 80mm).

Height mm	Width mm	PU	Item No.
80	51	60	30005521

NGP Liquid Caps

Caps, double level presentation



Space for all flavours!

With the POS-T Duplex Pusher you can double your shelf space for liquid caps and pods while maintaining the same shelf space. This creates space for all flavours with all nicotine strengths - without reducing your RMC range.

- For all product widths from 56 - 78mm
- Up to 12 products fit in one facing
- No conversion of existing rack systems necessary
- NGP - Displays in the counter area can be reduced

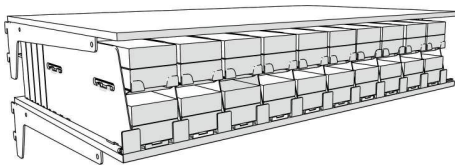
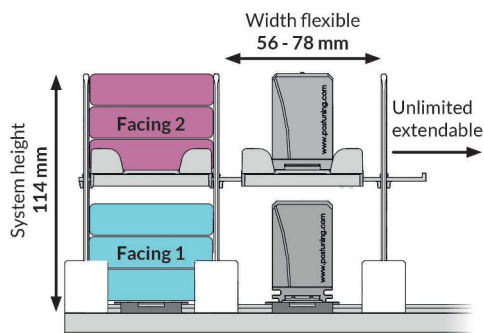

POS-T Duplex Pusher for a double-level presentation

Set for 20 facings consists of the following components:

- 11 x Divider
- 10 x middle shelves
- 20 x SloMotion Pushfeeds

For product widths from 56-76mm.

No. of Facings	Depth mm	PU	Item No.
20	310	1	30006906
20	395	1	30006847

Other depths and versions on request.

NGP

Liquid bottles

Liquids, staying presentation

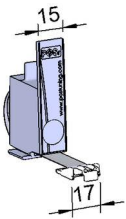

Tilt-resistant front presentation of small liquid bottles (without or with outer carton).

For the presentation of staying liquids you need in addition to the pushfeed:

- Adapter-T Rail
 - Guiderail, width 19mm (only for bottles without carton)
 - Divider, height 60mm
 - For round products, it is recommended to fix the dividers at the back of the shelf on an Adapter-T Rail. For this the dividers must be longer than the guiderail.
- These are described in the chapter **system components**.

Pushfeed, width 15mm, height 68mm, light gray

With front anchor W 17 x H 5mm, without front stop.

Max. capacity mm	Force Newton	PU	Item No.
340	1.5	203	30004446

Liquids, lying presentation

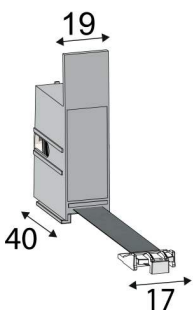

Perfectly showcased, perfectly presented - the horizontal presentation of liquids in cartons also fits between very narrow shelf spaces. Due to the controlled slow feed with the POS-T SloMo Pushfeed, the products do not fall off the shelf.

For the presentation of lying liquids you need in addition to the pushfeed:

- Adapter-T Rail
 - Guiderail, width 19mm
 - Divider, height 35mm with narrow front stop
- These are described in the chapter **system components**.

POS-T Mini SloMo, with damper, width 19mm, height 67mm, depth 40mm, light gray

With front anchor W 17 x H 5mm without front stop. Only with use of dividers.

Delay the advancement of very small and light products and thus prevents noise or tilting. For products from 19 to 45mm width. Also for stacked products.

Max. capacity mm	Force Newton	PU	Item No.
540	4	144	30006340

NGP

Liquid bottles

Liquid display



Presentation solution for **liquids** consisting of the Pushfeed- and Divider-System, fitting all standard shelves.

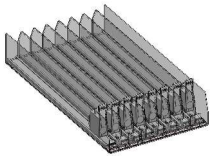

Liquid display, transparent

With 8 or 12 facings consisting of divider and pushfeed. For use with bottle and/or box packaging.

Dimensions WxDxH mm	No. of Facings	PU	Item No.
196x285x73	8	2	30001173
196x360x73	8	2	30001174
293x285x73	12	2	30001175
293x360x73	12	2	30001176

Other measurements upon request.

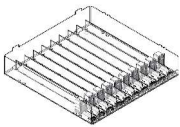

Stacked display for liquids, transparent

With 10 facings consisting of divider and pushfeed. For use with horizontally presented box packaging.

Dimensions WxDxH mm	No. of Facings	PU	Item No.
315x374x79	10	18	30001805

Other measurements upon request.

NGP

Vapour equipment

Divices and starterkits



For the presentation of devices and starterkits you need in addition to the pushfeed:

- Adapter-T Rail
- Divider, height 60mm

These are described in the chapter **system components**.

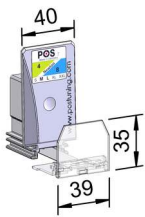

Pushfeed with 35mm front stop, width 40mm, height 75mm, depth 35mm, light gray

With front anchor W 39 x H 35mm, front gap 22mm.

Max. capacity mm	Force Newton	PU	Item No.
560	4-8	100	30004531

E-Shisha pop-up display



Optimal presentation solution for e-shisha products:

- more attention and order for your E-Shisha products
- optimal use of space
- more varieties in the same space
- quick and easy installation by simply plugging together
- perfect product presentation through optional pushfeeds



E-Shisha pop-up display, for 30 facings, transparent

Pop-up display (Item. no. 30010315) with 3 presentation levels and pre-installed Adapter-T Rails. For optimal product presentation, please order separately the **pushfeed set** (Item no. 30010429, set contains pushfeeds, dividers and guiderails).

External dimensions E-Shisha pop-up display: W 312 x D 328 x H 380mm

Details	PU	Item No.
Pop-up Display	1	30010315
Set Pushfeeds	1	30010429

E-Shisha, staying presentation



For the presentation of E-Shishas you need in addition to the pushfeed:

- Adapter-T Rail
- Divider, height 60mm

These are described in the chapter **system components**.

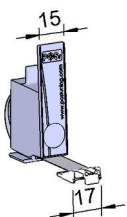

Pushfeed, width 15mm, height 68mm, light gray

With front anchor W 17 x H 5mm, without front stop.

Max. capacity mm	Force Newton	PU	Item No.
340	1.5	203	30004446

NGP

E-Shishas disposable



Pushfeed with labelholder, width 28mm, height 75mm, light gray

With labelholder for labels W 26 x H 63mm. With front anchor W 17 x H 5mm, without front stop. For guiderail F001.

Max. capacity mm	Force Newton	PU	Item No.
340	1.5	100	30010381

E-Shisha, lying presentation



For the presentation of e-shishas, lying on top of each other, you will need, in addition to the SloMo pushfeed:

- Guiderail F001 (*mandatory for dampened pushfeeds*)
 - Adapter-T Rail
 - Divider, height 60 or 100mm depending on stack height (pushfeed height 67mm)
- These are described in the chapter **system components**.

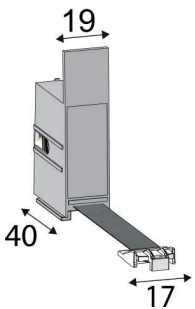

POS-T Mini SloMo, with damper, width 19mm, height 67mm, depth 40mm, light gray

With front anchor W 17 x H 5mm without front stop. Only with use of dividers. Delay the advancement of very small and light products and thus prevents noise or tilting. For products from 19 to 45mm width. Also for stacked products.

Max. capacity mm	Force Newton	PU	Item No.
540	4	144	30006340

NGP

E-Shishas disposable



Pushfeed with labelholder, width 28mm, height 114mm, light gray

With labelholder for labels W 26 x H 106mm. With front anchor W 17 x H 5mm, without front stop. For guiderails F001.

Max. capacity mm	Force Newton	PU	Item No.
340	4-5	100	30010382

NGP

Oral Tobacco tins



Honeycomb channel

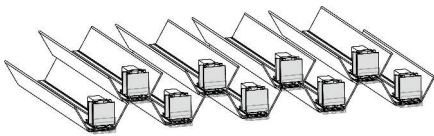
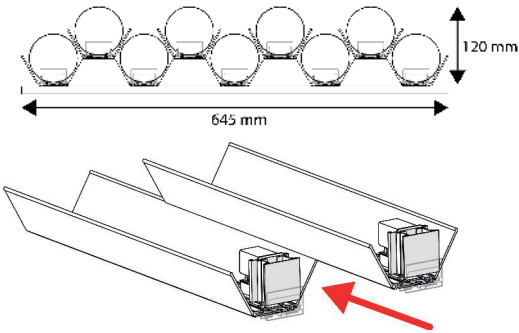

Bees are smart!

Due to the special hexagon construction of their honeycombs, bees not only make optimum use of the available space - they also achieve the highest possible stability. And as the saying goes, we should learn from the animals.

With the POS-T honeycomb channel for your oral tobacco tins there are no limits. Flat or high constructions - everything is possible. Make optimum use of the available space and present your tins in the best possible way. For all cans with a diameter of 69 - 72mm.

Also suitable for standard shelf spacing of 127mm.

POS-T Honeycomb Channel for oral tobacco tins

A set for 9 facings consists of the following components:
 - 9 x honeycomb channels with integrated pushfeed

No. of Facings	Depth mm	Item No.
9	357	30006918

Other depths and versions on request.

Accessories for honeycombs

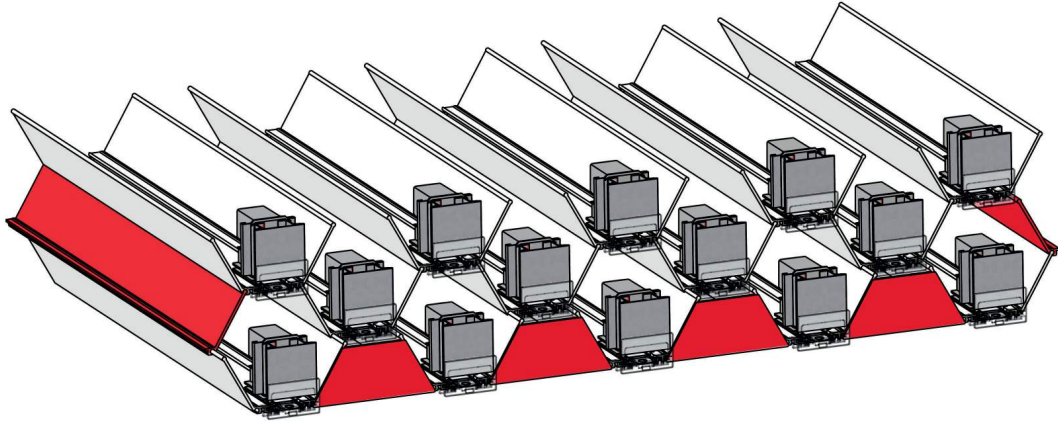

Honeycomb Faceplates

Optional faceplates can be installed on the lowest level of the honeycombs. The faceplates are simply attached on the Adapter-T Rail.

Individual printing on the faceplates ensures even more attention. We are happy to advise you.

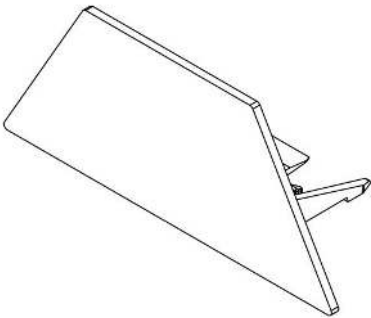

PU	Item No.
4	30007982

Honeycomb side walls

If you build your honeycombs higher than 2 levels, you need one set of side walls per level.

Set consists of:
- left side wall
- right side wall

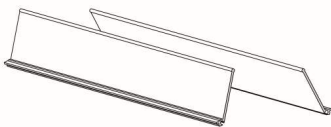

Depth mm	Item No.
340	30007452

NGP

Oral Tobacco tins

Modular stacking channels



The presentation of round chewing tobacco packaging can be a real challenge. Stacking is difficult, there is no clear overview and there is certainly a high risk of the products falling over. The perfect solution are modular, stackable channels. They can be easily integrated into existing shelving systems and make optimum use of the space. This form of product presentation provides quick orientation for both the retailer and the shopper. The products can be presented standing up and lying, providing an optimal overview. The integrated pushfeed makes it easy to remove and filling the products, without the packagings are tipping over or turning away. Truly an "all-round" talent.

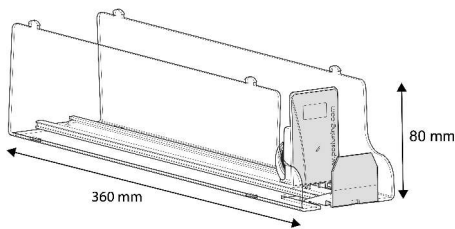

Oral-Tobacco-Channel stackable, 68 -73mm diameter, transparent

Stackable pushfeed channel for all oral tobacco tins. Easy installation on all POS-T Adapter-T Rails.

Any number of channels can be stacked on top of each other.

For the upper end of a stack we recommend the channel, item no. 30006548.

Dimensions WxDxH mm	Force Newton	PU	Item No.
81x360x80	2	6	30006549

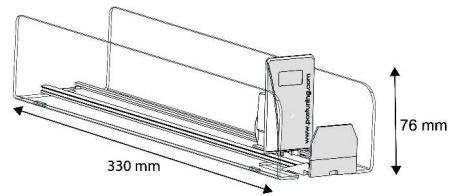

Oral-Tobacco-Channel for upright tins, 68 -73mm diameter, transparent

Pushfeed channel for all oral tobacco tins.

This channel can be easily installed on all POS-T Adapter-T Rails, or can be used as an upper end channel for the stackable channels, item no. 30006868 and 30006549.

Dimensions WxDxH mm	Force Newton	PU	Item No.
81x330x76	2	6	30006548

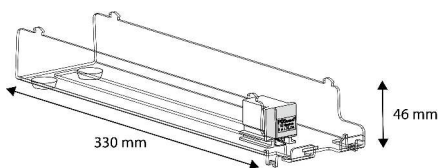

Stackable Oral-Tobacco-Channel for horizontal cans with 68 -73mm diameter and max. 30mm depth, transparent

Lower pushfeed channel for a horizontal presentation of oral tobacco tins.

Only in combination with pushfeed channel, item no. 30006548.

Dimensions WxDxH mm	Force Newton	PU	Item No.
81x330x46	2	6	30006868

NGP Oral Tobacco tins

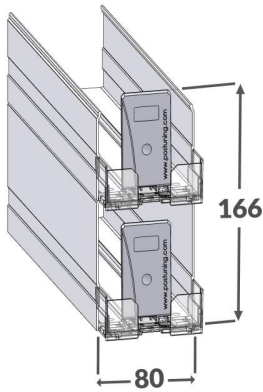

Oral-Tobacco Channel for upright tins, stackable, 68 - 73 mm diameter, white

Stackable pushfeed channel for all oral tobacco tins. Easy installation on all POS-T Adapter-T Rails.

Dimensions WxDxH mm	Force Newton	PU	Item No.
80x297x166	2	5	30011247

Further configurations available on request.

Rolling presentation

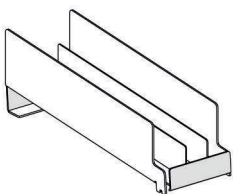
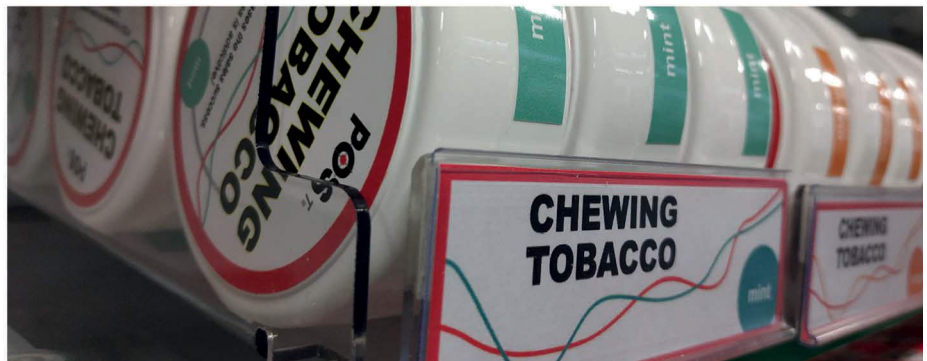

Shelf presenter for round oral tobacco tins

Space-saving presentation, always in front - the roll presenter for round oral tobacco tins.

By tilting slightly, the tins roll to the front of the shelf. Each presenter has 3 facings, for example for different nicotine strengths.

With the optional adhesive flap holder for a frontally presented tin, the orientation and staging is also given.

Dimensions WxDxH mm	Max. filling quantity	PU	Item No.
303x91x111	3 x 4 tins	2	30006867
373x91x117	3 x 5 tins	2	30006869

NGP

Oral Tobacco tins

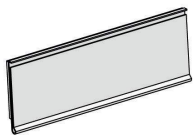

Communication holder for roll presenter

For adhesive mounting on the front of the roll presenter. For communication labels W 88 x H 30mm.

Dimensions WxDxH mm	PU	Item No.
88x30	6	30007324



Presentation solutions for

EU TPD2

TOBACCO PRODUCT REGULATION



High-stacked
 - Horizontal presentation
 with POS-T SloMo Pushfeeds

100% brand showcasing
 - with the POS-T Brandline Profiles,
 your brands are in the limelight.



No game-playing
 - with the POS-T Product Cards,
 sold in their millions, better brand
 focus is not a game of chance.



TOBACCO IN TRANSITION

TPD2 – THE NEW TOBACCO LAW

GET YOUR OWN PICTURE

There was outrage in 2014 when the European parliament passed the regulation on tobacco products. The TPD2 law changed the whole tobacco market. Even today, we are not used to the images used as a warning. The reasons why you should consider a change of tobacco presentation at the point-of-sale are numerous. An impressive overall image and better focus on brand through the mess of shocking images are only two examples.

With our solutions, the lighting system for example, you can steer the attention towards your brand – whilst complying with all legal stipulations.

OVERVIEW OF THE NUMBERS

ONLY **35%** of brand communication remains the same for a normal cigarette display. Better, however, is...

...**100%** the visibility of your brand thanks to a stacked display.

...**100%** focus on the brand thanks to the correct lighting provided by the brandline profile.

THE EXPERTS AT THE POINT OF SALE!

We are your global partner when it comes to selling tobacco goods. Regardless of whether you are selling king-size, big or small packs, round chewing tobacco tins or modern e-cigarettes in a cap or liquid system. And regardless of whether the presentation is horizontal or vertical – all products are staged optimally. Furthermore, we have all the answers to the problems of the future – changing legal requirements and the reduction of available shelf space. We have many years of experience, meaning we are reliable specialists in your market segment.



THE CATEGORY PROBLEMS

Up to 70% of cigarette displays must be labelled with warnings and shocking images.

Finding the desired product then becomes significantly more difficult.



THE PERFECT SOLUTION

Presentation solutions from POS TUNING have been specially designed for the characteristics of a TPD2 cigarette shelf.



THE RESULT

Better visibility of brands

Shorter search times for shoppers and vendors

With the same level of comfort – easy to take out and easy to fill

Content

lying presentation	Page	72	-	72
Brand Illumination Profile	Page	73	-	75
Product Cards	Page	76	-	76
Faceplate with label sleeve	Page	77	-	77

TPD2

lying presentation



Show your products from their best side

Due to a horizontal presentation, the visibility is exclusively on the brand.
Perfect handling through controlled slow forward movement with SloMo Pushfeed.

For this presentation you need in addition to the pushfeed:

- Adapter-T Rail
- Guiderail, width 34mm
- Divider, height 100 or 12mm

These are described in the chapter **system components**.

King Size and Big Packs

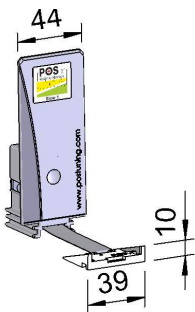

For product widths over 54mm.

Pushfeed with damper, width 44mm, height 110mm, depth 40mm, light gray

Damped pushfeed with universal strength for all stacked tobacco and NGP products from 54mm width. Without front stop, products stop at the dividers. Front gap 22mm.

Max. capacity mm	PU	Item No.
540	100	30004409

TPD2

Brand Illumination Profile

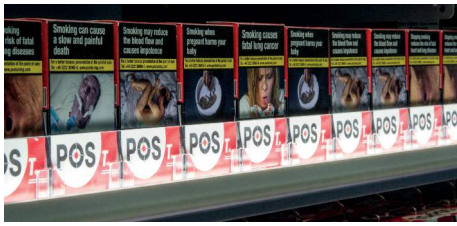

With the aid of a special shelf rail, an LED light strip and a front riser, an illuminated space is created, which only highlights the brand at the bottom of the pack. The remaining parts of the package are obscured by a shadow.

LED Lighting Profiles

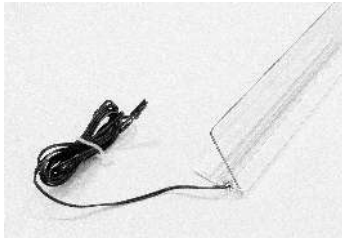

Brand Illumination Rail E003 with FlexLED, self-adhesive, silver gray

Highlight the brand at the bottom. Suitable for installation on metal, glass or wood shelves. Alternatively, the profile can be fitted to existing Adapter-T Rails of POS TUNING. Dividers fitted on this rail must be shorter by 25mm than the ones used with other adapter rails. Integrated connection cable with a length of 700mm.

For power collector, 6-way splitter or extension cable

Length mm	Shelf width mm	Nominal Width mm	PU	Item No.
595	600	600	10	30005099
645	650	650	10	30004785
895	900	900	10	30005100
995	1,000	1,000	10	30001196
1,245	1,250	1,250	10	30005101
1,325	1,330	1,330	10	30005102

Other measurements upon request.

Power supply via bus bar

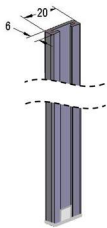

Enables a simple, easy and fast installation with the POS TUNING FlexLED lighting system.

Bus bar, self-adhesive, dark gray

With cap.

Length mm	Depth mm	Width mm	PU	Item No.
900	6.2	20	1	30005086
1,200	6.2	20	1	30005869

Other measurements upon request.



Power collector with 1-fold socket, 12/24V, silver

Height mm	Depth mm	Width mm	PU	Item No.
20	12	58	1	10000155

TPD2

Brand Illumination Profile



Feeder for bus bar

With ESP plug for power supply unit 24 Volt.

Length mm	PU	Item No.
2,500	1	10000403

Power supply with cable distributor



Conventional installation of POS TUNING Flex LED lighting systems.

Extension cable FlexLED

Allows extension of cable connection between splitter and FlexLED cable.

Length mm	PU	Item No.
2,000	200	10000641



6-way splitter for FlexLED system, magnetic

Multiple splitter for FlexLED to expand to 6 connecting sockets.

Length mm	No. of connections	PU	Item No.
150	6	200	10000401

Power Supply



The right power supplies for your application.

Power supply 24V

For the power supply of LED-lighting elements. For connection to feeder for bus bar or 6-way splitter. Cable length 2000mm. For max. 5 meters LED.

Note: Do not install the power supply units in closed cabinets - open air circulation must be ensured.

max. LED m	Watt W	PU	Item No.
5	30	1	10000763



Build-in power supply 24 V

For the power supply of LED-lighting elements. For connection to feeder for bus bar or 6-way splitter. Cable length 2000mm. For max. 12,5 meters LED.

max. LED m	Watt W	PU	Item No.
12.5	75	1	30004455

TPD2

Brand Illumination Profile

Accessories

Accessories for cable based FlexLED Shelf Lighting System and bus bar system.

Conduit for bracket, magnetic, white

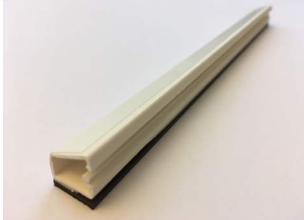

Length mm	Height mm	Width mm	PU	Item No.
200	10	12.5	50	30002073

Fixing clamp for cable, self-adhesive, white

With flexible clamp.



Length mm	PU	Item No.
19	10	10000243

Multiple socket, white

1500mm supply line.



Length mm	PU	Item No.
1,500	1	30000047

Schuko extension cable, white

H05VV-F3G 1,5mm.



Length mm	PU	Item No.
3,000	1	10000224

TPD2

Product Cards



With the help of an adapter clip that is inserted behind the front anchor of the Pushfeed, a product card is placed in front of the packs. This product card is printed with the layout of the brand placed behind it, just like those from tobacco vending machines. The product card is flexible with an expected lifetime of many thousand product removals.

Adapter clips

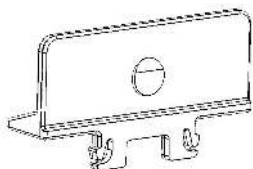

Adapter-Clip RMC, width 34mm, height 18.5mm, transparent

For front anchor with width of 39mm. For holding product cards with punched hole for cigarette packs.

PU	Item No.
500	30000156

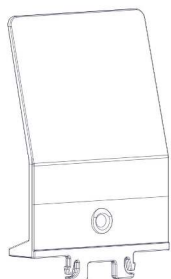

Adapter clip RYO, width 34mm, height 51.8mm, transparent

For front anchor with width of 39mm. For holding product cards with punched hole for RYO pouches.

PU	Item No.
250	30000152

Individually printed Product Cards

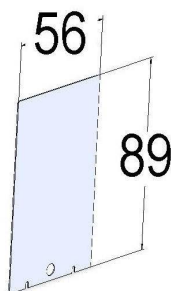

Product Card Set, width 56mm, height 89mm, mat, white, printed (4C)

Suitable for all cigarette packs of width 55mm, insertable between Adapter-Clip RMC and Pushfeed.

PU	Item No.
1	10000468

Other measurements upon request.

TPD2

Faceplate with label sleeve



Alternatively to the Product Card the Faceplate features a clear sleeve for use with exchangeable paper labels. It is plugged upon the pushfeed's front (front anchor with 39mm width) and thanks to its integrated hinge it can be easily opened for removal and filling. The Faceplate is self-closing.

Faceplate for Kingsize and Big Packs

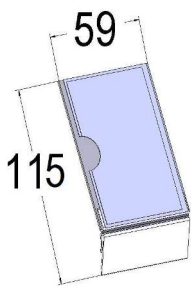

TPD2 flap for King Size, with rectangular pocket, fits on front anchor with width of 39mm, white

With hinge. Label sleeve on front side for use with paper labels.

Dimensions WxDxH mm	PU	Item No.
59x5x115	300	30002176



Presentation solutions for the

Plain Packs

PLAIN PACKAGING

death

death

For a better tobacco presentation at the point of sale:
Tel: +49 5222 36965-0, www.postuning.com

For a better tobacco presentation at the point of sale:
Tel: +49 5222 36965-0, www.postuning.com

For a better tobacco presentation at the point of sale:
Tel: +49 5222 36965-0, www.postuning.com



POS Tuning
Plain packaging

POS Tuning
Plain packaging

POS Tuning
Plain packaging

Unobstructed
- with the POS-T Pushfeed System for plain packs, you can find your brand faster and better.

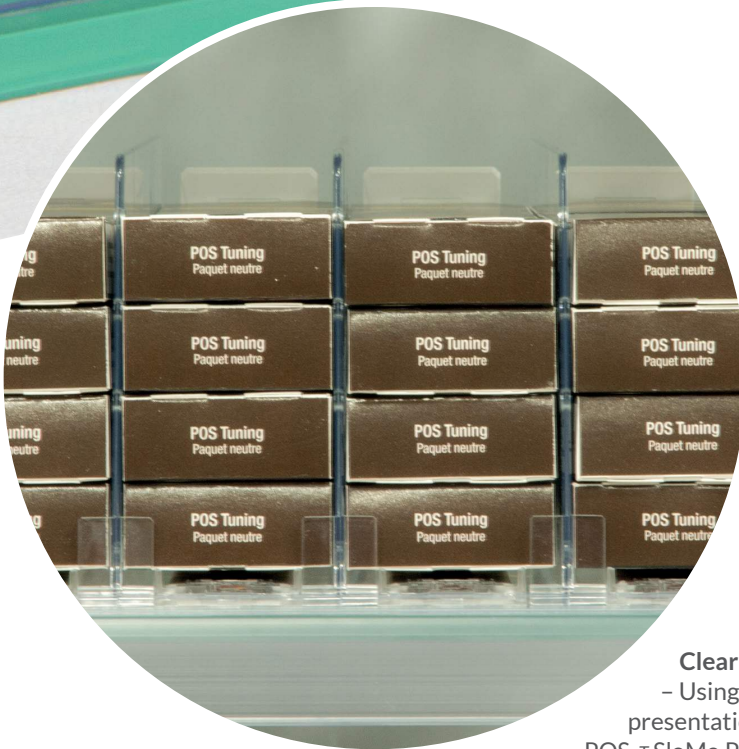

Clear view
- Using a horizontal presentation with the POS-T SloMo Pushfeed Systems, you can get a better overall view.



STANDARDIZED PACKAGING IN THE TOBACCO SECTOR – PLAIN PACKAGING

SHORTEN SEARCH TIME

More and more countries are changing their legislation to stipulate that tobacco products cannot display brands or advertising. France, Australia, Belgium, Turkey and Great Britain are just some examples.

The result: Plain packaging at the point of sale – normally in olive-brown. It's not pretty and also makes finding products more difficult for customers and vendors.

Our solutions for the point of sale ensure that your brand gets attention and the best visibility possible on the tobacco shelf in spite of this.

OVERVIEW OF THE NUMBERS

4 x of the brand text is seen by the customer and vendor in a stacked, horizontal display

+ 100% Legibility of the brand text means you can find products faster

THE EXPERTS AT THE POINT OF SALE!

We are your global partner when it comes to selling tobacco goods. Regardless of whether you are selling king-size, big or small packs, round chewing tobacco tins or modern e-cigarettes in a cap or liquid system. And regardless of whether the presentation is horizontal or vertical – all products are staged optimally. Furthermore, we have all the answers to the problems of the future – changing legal requirements and the reduction of available shelf space. We have many years of experience, meaning we are reliable specialists in your market segment.



THE PROBLEM

Plain packs are a challenge when it comes to finding products.

Finding the correct product takes significantly longer than it would with graphic brand logos.

Conventional pushfeed systems often cover the brand text.



THE PERFECT SOLUTION

Pushfeed systems especially for Plain Packs for maximum brand visibility

Horizontal or vertical front presentation

(Alpha)numerical searching aids



THE RESULT

The best view of brand text facilitates the search for the right product

Improved focus thanks to a tidier shelf appearance.

With a horizontal display with POS-T SloMo Pushfeed System.

Know exactly what is where with the POS-T Orientation Clips.

Content

upright presentation	Page	84	-	84
lying presentation	Page	85	-	85
Orientation on the shelf	Page	86	-	86

Plain Packaging upright presentation



For the presentation of plain packs you need in addition to the pushfeed:

- Adapter-T Rail
 - Divider, height 35mm with high front stop
- These are described in the chapter **system components**.

King Size and Big Packs

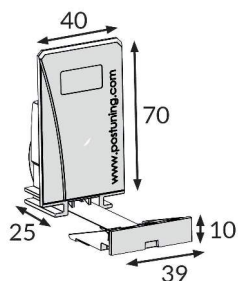

Pushfeed, width 40mm, height 70mm, depth 25mm, light gray

With front anchor W 39 x H 10mm without front stop. Products stop at the divider side stop. With small clamping range of 16mm.

Max. capacity mm	Force Newton	PU	Item No.
390	2	140	30006838

Ultra Slims

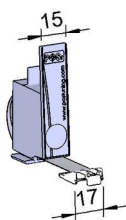

For products under 48mm width.

Pushfeed, width 15mm, height 68mm, light gray

With front anchor W 17 x H 5mm, without front stop.

Max. capacity mm	Force Newton	PU	Item No.
340	1.5	203	30004446

Plain Packaging lying presentation

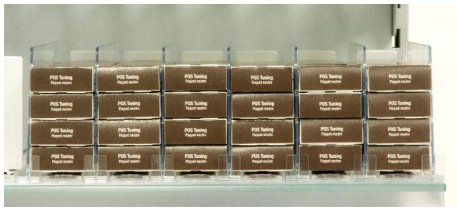

Better legibility of brand texts

Due to the presentation of lying packages in the steck, the visibility lies exclusively on the brand text.

Perfect handling through controlled slow forward movement with SloMo Pushfeed.

For this presentation you need in addition to the pushfeed:

- Adapter-T Rail
- Guiderail, width 34mm
- Divider, height 100 or 120mm

These are described in the chapter **system components**.

King Size and Big Packs

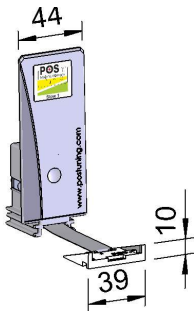

Pushfeed with damper, width 44mm, height 110mm, depth 40mm, light gray

Damped pushfeed with universal strength for all stacked tobacco and NGP products from 54mm width. Without front stop, products stop at the dividers. Front gap 22mm.

Max. capacity mm	PU	Item No.
540	100	30004409

Plain Packaging

Orientation on the shelf

Orientation examples



Numerical orientation

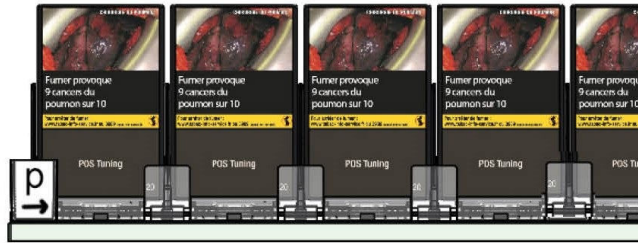

Alphanumerical orientation

Divider clips for orientation

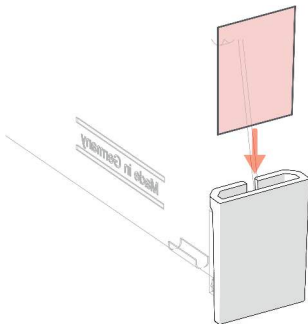

Divider clips for orientation labels

Orientation is that simple!

Simply put it on the divider and each facing has its own labelholder for an individual orientation hint.

For labels: W 17 x H 26mm

We recommend paper from 160g.

One set contains 25 divider clips.

PU	Item No.
1	30007359



Presentation solutions for the

Dark Market

DISPLAY BAN FOR CIGARETTES



Plug & play
Dark Market shutters from POSTUNING are easily adapted to the existing Pushfeed System.



Stands alone
Dark Market Face-plates are single flaps, attachable in seconds to an existing pushfeeds.



Maximise the use of your drawers!
The POST Multi Row allows several varieties in one row. With a single facing, it can easily make 3 or even 4 facings. Maximise your product variety without taking up extra space.



SHELF SOLUTIONS FOR THE DARK MARKET

TIGHTER LEGAL SITUATION

The days of smoking in thrillers, films or TV shows are over. In many countries, there are also laws concerning the point of sale which stipulate that tobacco goods may no longer be visible. This is now known as the "dark market".

Canada, Australia, England, Russia and the Netherlands are only examples of the countries in which a change in legislation concerning the dark markets has already been introduced. And the situation is bleak – dark markets will soon be the reality. Prepare yourself for the future.

With our dark market solutions, you can modify your shelf in just a few seconds – all without tools.

OVERVIEW OF THE NUMBERS

ONLY **10** seconds is all you need to make an existing tobacco shelf 'dark-market-ready'.

100% Adapts to the existing POS-T Pushfeed System. You don't need to change your shelf completely.

THE EXPERTS AT THE POINT OF SALE!

We are your global partner when it comes to selling tobacco goods. Regardless of whether you are selling king-size, big or small packs, round chewing tobacco tins or modern e-cigarettes in a cap or liquid system. And regardless of whether the presentation is horizontal or vertical – all products are staged optimally. Furthermore, we have all the answers to the problems of the future – changing legal requirements and the reduction of available shelf space. We have many years of experience, meaning we are reliable specialists in your market segment.



THE PROBLEM

Dark Market means the end of visible display for tobacco products.

Instead of displaying products, goods will be stored behind doors or under the counter.

Many retailers or brand manufacturers think, that making existing tobacco gantries compliant with the law may cost a fortune.



THE PERFECT SOLUTION

Dark market solutions from POS Tuning are compatible with your POS-T Pushfeed System.



THE RESULT

Conversion in only a few seconds.

Push-in systems can be removed to restock.

High-value appearance, shutters with printable surface and easy to use.

Content

Flap solutions for shelves	Page	92	-	92
Flap solutions for single facings	Page	93	-	93

Dark Market

Flap solutions for shelves



Flaps and hinges

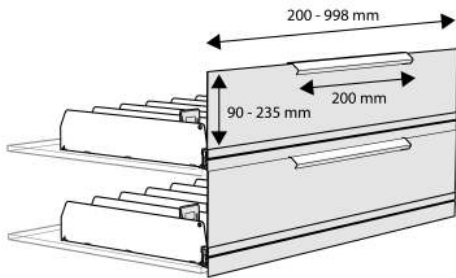

Dark Market flap with Handle

Flap solution for quick upgrade of existing shelving systems. Opening from top to bottom.

Individually adaptable to your shelf dimensions

Maximum flap height (shelf distance) = 235mm
Maximum flap width = 1.000mm

Set for 10 flaps, consisting of

- 10 flaps
- 10 hinge profiles
- 10 handles
- 1 cutting aid
- 1 carpet knife

Easy to adapt with the divider clip item no. 30007360.

Dimensions WxDxH mm	Colour	PU	Item No.
Indiv./ max. B998 x H235	white	1	30008556
Indiv./ max. B998 x H235	black	1	30008557

Adaptation at the divider

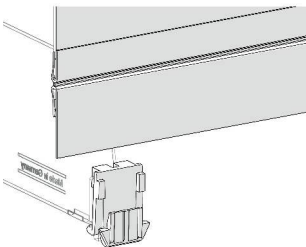

25 divider adaption clips for flaps

Upgrade within seconds.

With the divider adaptation clips you can easily fix your Dark Market flap - without having to convert the shelf at great expense.

We recommend an adaptation clip every 20cm.
1 set contains 25 pieces of divider clips.

PU	Item No.
1	30007360

Dark Market

Flap solutions for single facings



With the faceplates from POSTUNING it is possible to hide single facings on the shelf.

The faceplate is attached to the front of the existing pushfeed and thus the tobacco product behind it is no longer visible. For removal or refilling, the faceplate can simply be opened downwards and closes again automatically.

Faceplates for Kingsize

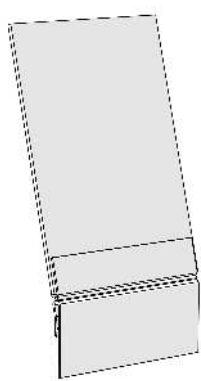

Dark market flap for King Size, 115 x 59mm

With clip-on hinge on front anchor or divider with max. frontstop height of 25mm.
For facing width 59mm.

Dimensions WxDxH mm	Colour	PU	Item No.
59x5x115	white	25	30008946
59x5x115	black	25	30008947



System solutions for

Shop fitters

THE RIGHT CIGARETTE PRESENTATION



Under the shop counter
– POS-T Lift Solutions and
Pushfeed Systems with
integrated stock display



Simple and clear
– The POS-T LED Profiles
and Cabling Systems for
shelves and shop counters



Especially slim
– POS-T Glass Shelves are
only 8mm thick and increase
the value of the entire shelf.

Maximise the use of your drawers!
The POS-T Multi Row allows several varieties in
one row. With a single facing, it can easily make 3
or even 4 facings. Maximise your product variety
without taking up extra space.



SYSTEM SOLUTIONS – SHOP FITTER'S COMPANION

TOGETHER ON THE FRONT LINE

High-value shop and counter fitting elements are unbeatable together with the pushfeed and function solutions offered by POS TUNING.

Use our expertise - we are your global partner when it comes to tobacco displays at the point of sale. Regardless of whether you are selling king-size, big or small packs, round chewing tobacco tins or modern e-cigarettes in a cap or liquid system. And regardless of whether the presentation is horizontal or vertical – all products are staged optimally.

Furthermore, we have all the answers to the problems of the future – changing legal requirements and the reduction of available shelf space. We have many years of experience, meaning we are reliable specialists in your market segment.



Flexible to use in all shop fitter system shelves.



Minimal distance between shelves with the POS-T Glass Shelves and Brackets ensures optimal use of shelf space.



Effective functional elements can be integrated into almost all sales equipment.



Content

Shelving parts	Page	100	-	101
Shelf lighting	Page	102	-	105

Systems for shopfitters

Shelving parts

Whether modernizing or just going for a new look – the glass shelves and brackets are compatible with your existing shelf systems. At low expense and with just a little retrofitting, you can achieve not only a facelift of your shelf units but also add up to 80 % more horizontal space for presentation on the glass shelves.

Glass shelves

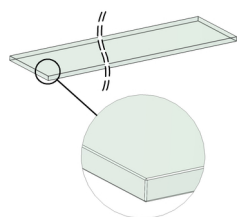

Glass shelves with rounded and polished edges.

Glass shelves, transparent

Height mm	Depth mm	Width mm	Item No.
8	380	598	70000093
8	380	648	70000097
8	380	662	70000099
8	380	898	70000118
8	380	998	70000124
10	380	1,246	70000138

Other measurements upon request.

Accessories



Brackets for glass shelves, silver

Made of 2mm steel sheet. With holes for fitting of glass shelves with rubber stoppers. Compatible with all shelving systems.

Depth mm	Hole pitch mm	PU	Item No.
320	30/60	20	70000141
320	35/70	20	70000142
320	40/42	20	70000144
320	45	20	70000148
320	50	20	70000152

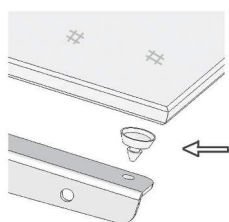

Rubber layer for glass shelves

4 pieces per pair of brackets required.

PU	Item No.
40	30000798

Systems for shopfitters

Shelving parts

Bracket adapter

For glass shelves, compatible with all shelving systems.
Delivery incl. screws, without rubber layers for glass shelves.

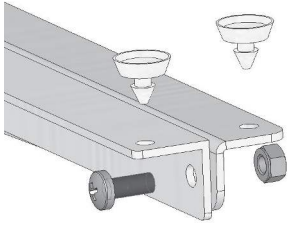

Depth mm	Hole pitch mm	PU	Item No.
272	20	20	30004871

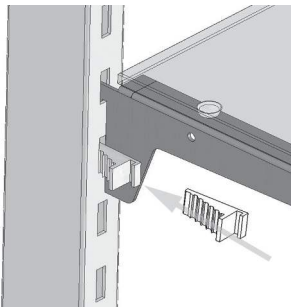

Security Grip, set of 10 pieces

Mandatory for the end-set, if the holes are wider than 8mm (except for 50mm hole pitch - Tegometall company).

PU	Item No.
1	30000801

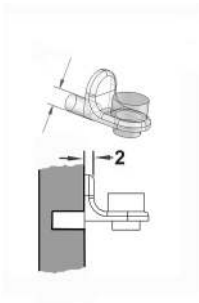

Glass truss 5/5 x 16mm, galvanized

For the installation in borehole walls. 2,5mm skew with tappet.

PU	Item No.
5,000	10000367

Systems for shopfitters

Shelf lighting

LED Lighting Profiles

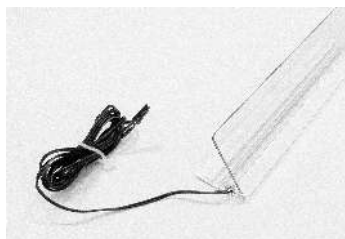

Brand Illumination Rail E003 with FlexLED, self-adhesive, silver gray

Highlight the brand at the bottom. Suitable for installation on metal, glass or wood shelves. Alternatively, the profile can be fitted to existing Adapter-T Rails of POS TUNING. Dividers fitted on this rail must be shorter by 25mm than the ones used with other adapter rails. Integrated connection cable with a length of 700mm.

For power collector, 6-way splitter or extension cable

Length mm	Shelf width mm	Nominal Width mm	PU	Item No.
595	600	600	10	30005099
645	650	650	10	30004785
895	900	900	10	30005100
995	1,000	1,000	10	30001196
1,245	1,250	1,250	10	30005101
1,325	1,330	1,330	10	30005102

Other measurements upon request.



Scanning profile S014 with FlexLED, height 39mm, 2-way adjustable, light gray

Scanning rail can be clipped on to shelf fronts with U-lip edge. Lead cable in length 700mm. Compatible with shelves of various manufacturers, such as Linde Ladenbau, Storebest, Tegometall, ITAB, Eden, Lüning Ladenbau.

Length mm	Shelf width mm	Nominal Width mm	PU	Item No.
588	600	600	10	30005094
638	650	650	10	30005095
888	900	900	10	30005096
988	1,000	1,000	10	30001190
1,238	1,250	1,250	10	30005097
1,318	1,330	1,330	10	30005098

Other measurements upon request.



Under mount profile E010 with FlexLED, self-adhesive

For installation under metal, glass, wood or plastic-shelf boards. Includes an integrated connection cable in 700mm length.

Length mm	Shelf width mm	Nominal Width mm	PU	Item No.
570	600	600	10	30005108
620	650	650	10	30005109
870	900	900	10	30005110
970	1,000	1,000	10	30005111
1,220	1,250	1,250	10	30005112
1,300	1,330	1,330	10	30005113

Other measurements upon request.

Systems for shopfitters

Shelf lighting



Under mount profile E010 with FlexLED, magnetic

For installation under metal shelves, includes an integrated connection cable in 700mm length.

Length mm	Shelf width mm	Nominal Width mm	PU	Item No.
570	600	600	10	30005103
620	650	650	10	30005104
870	900	900	10	30005105
970	1,000	1,000	10	30001197
1,220	1,250	1,250	10	30005106
1,300	1,330	1,330	10	30005107

Other measurements upon request.

Power supply via bus bar

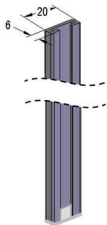

Enables a simple, easy and fast installation with the POS TUNING FlexLED lighting system.

Bus bar, self-adhesive, dark gray

With cap.

Length mm	Depth mm	Width mm	PU	Item No.
900	6.2	20	1	30005086
1,200	6.2	20	1	30005869

Other measurements upon request.



Power collector with 1-fold socket, 12/24V, silver

Height mm	Depth mm	Width mm	PU	Item No.
20	12	58	1	10000155



Feeder for bus bar

With ESP plug for power supply unit 24 Volt.

Length mm	PU	Item No.
2,500	1	10000403

Systems for shopfitters

Shelf lighting

Power supply with cable distributor



Conventional installation of POS TUNING Flex LED lighting systems.

Extension cable FlexLED

Allows extension of cable connection between splitter and FlexLED cable.

Length mm	PU	Item No.
2,000	200	10000641

6-way splitter for FlexLED system, magnetic

Multiple splitter for FlexLED to expand to 6 connecting sockets.

Length mm	No. of connections	PU	Item No.
150	6	200	10000401

Power supplies



The right power supplies for your application.

Power supply 24V

For the power supply of LED-lighting elements. For connection to feeder for bus bar or 6-way splitter. Cable length 2000mm. For max. 5 meters LED.

Note: Do not install the power supply units in closed cabinets - open air circulation must be ensured.

max. LED m	Watt W	PU	Item No.
5	30	1	10000763

Build-in power supply 24 V

For the power supply of LED-lighting elements. For connection to feeder for bus bar or 6-way splitter. Cable length 2000mm. For max. 12,5 meters LED.

max. LED m	Watt W	PU	Item No.
12.5	75	1	30004455

Systems for shopfitters

Shelf lighting

Accessories

Accessories for cable based FlexLED Shelf Lighting System and bus bar system.

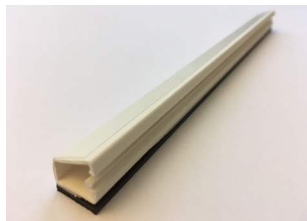

Conduit for bracket, magnetic, white

Length mm	Height mm	Width mm	PU	Item No.
200	10	12.5	50	30002073

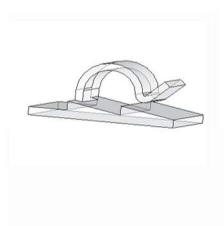

Fixing clamp for cable, self-adhesive, white

With flexible clamp.

Length mm	PU	Item No.
19	10	10000243



Multiple socket, white

1500mm supply line.

Length mm	PU	Item No.
1,500	1	30000047



Schuko extension cable, white

H05VV-F3G 1,5mm.

Length mm	PU	Item No.
3,000	1	10000224

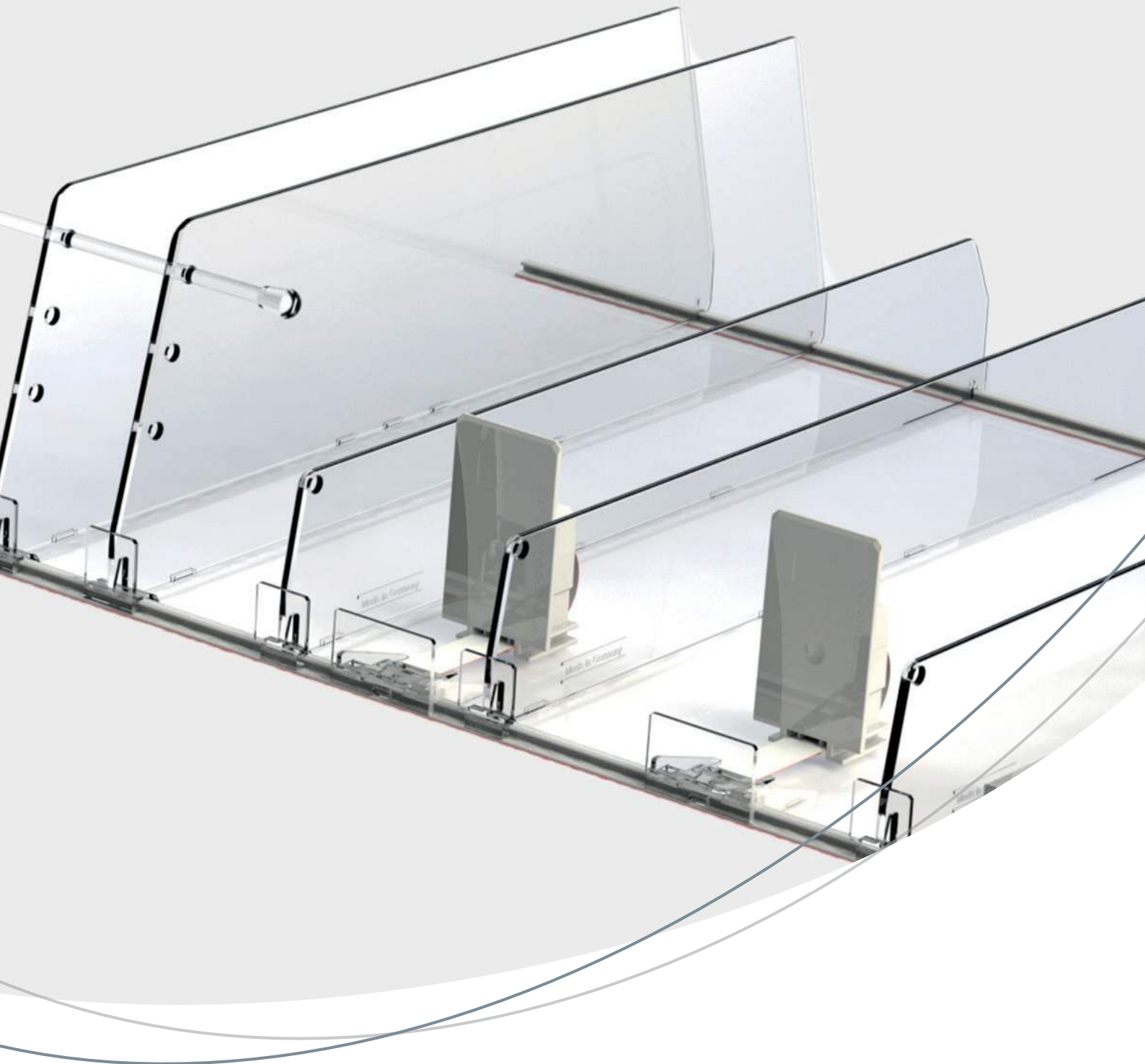

An overview

System components

DIVIDERS, MOUNTING PROFILES AND ACCESSORIES



Attention to detail
The POS-T Dividers are not just “plastic sheets”, they are a system with many intelligent details.



Stoppers
POS-T Adapter Profiles for all conventional shelf types and sizes.



Lane assistant
POS-T Guiderails ensure that even products likely to fall stay in place.

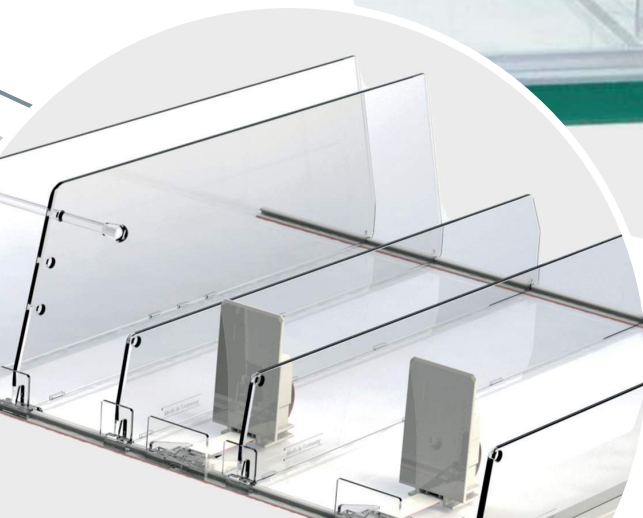

PRACTICAL UTENSILS – SYSTEM COMPONENTS

EVERYTHING YOU NEED IS INCLUDED



POS- τ Adapter-T Profiles

POS- τ Adapter-T Profiles fix the front or furthest back dividers or pushfeed systems on all customary shelf surfaces. They adapt optimally to the respective goods holder. Transparent profiles ensure a clear view of the product.



POS- τ Guiderails

POS- τ Guiderails reduce friction between the shelf surface and the product. This not only protects the product but also makes restocking easier.



POS- τ Dividers

POS- τ Dividers ensure clear structures and help the shopper and vendor find products. Search and access times are reduced and the rate of impulse purchases is quantifiably increased. Depending on the product and use, we offer dividers at heights of 35, 60, 100 or 120mm and at lengths from 80 to 580mm.

OVERVIEW OF THE NUMBERS

+ 93% of all shoppers questioned in a survey indicated that a tidy and well-organised shelf is the most important criterion for the place of purchase when making a decision.

+ 40% of sales assistants' time is used to fix the shelf and "selling is a secondary task" and taking care of the shelf is very demotivating.

THE EXPERTS AT THE POINT OF SALE!

We are your global partner when it comes to selling tobacco goods. Regardless of whether you are selling king-size, big or small packs, round chewing tobacco tins or modern e-cigarettes in a cap or liquid system. And regardless of whether the presentation is horizontal or vertical – all products are staged optimally. Furthermore, we have all the answers to the problems of the future – changing legal requirements and the reduction of available shelf space. We have many years of experience, meaning we are reliable specialists in your market segment.

Content

Adapter-T Rails	Page	112	-	120
Divider	Page	121	-	128
Guidrails	Page	129	-	130
Complete shelf equipment	Page	131	-	132
Flexible shelf equipment	Page	133	-	133

System components

Adapter-T Rails



Adapter-T Rails for fixation of System Elements (e.g. dividers and pushfeeds) on standard shelving units. Depending on the shelf type, installation of the Adapter-T Rails is done easily by either sticking, plugging, clipping or using a magnet to attach to shelf.

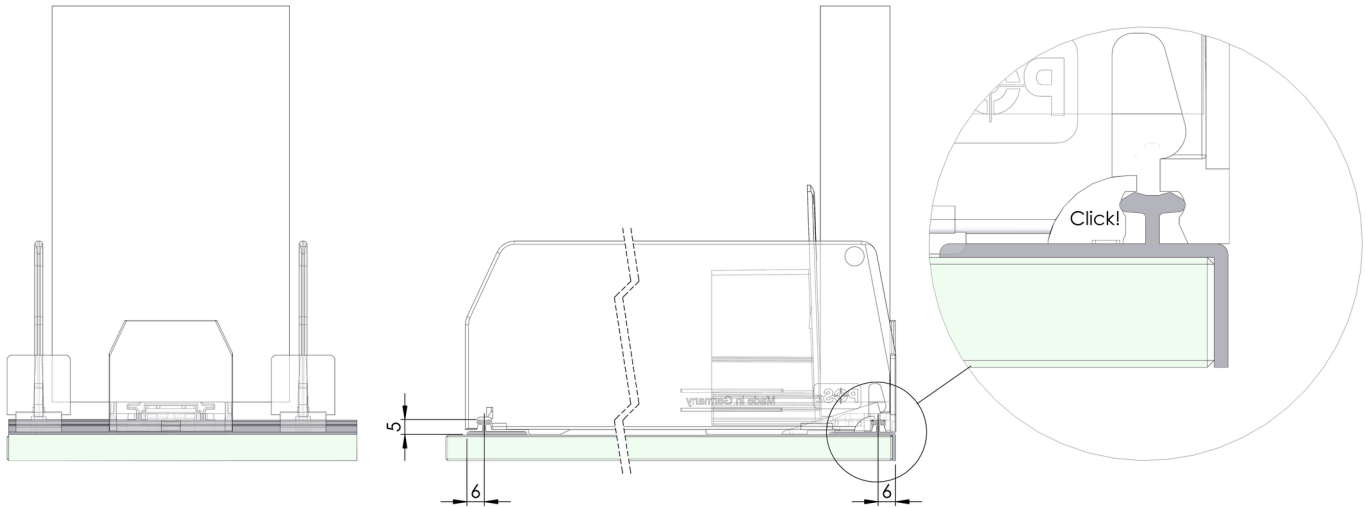

System components

Adapter-T Rails

Without lower/upper bend

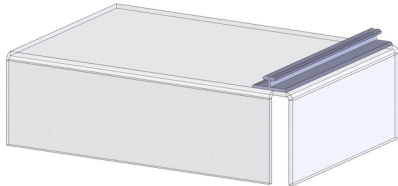

Adapter-T Rails for the fixation of System Elements e.g. dividers and pushfeeds on standard wooden, glass and metal shelves.



Adapter-T Rail A001, self-adhesive, transparent

Recommended for light products. Good bonding to glass, metal and wood shelves. With transparent film adhesive tape.

Shelf width mm	Length mm	PU	Item No.
600	595	80	30002395
650	645	80	30002397
665	660	80	30002399
900	895	80	30002405
1,000	995	80	30002408
1,250	1,245	80	30002409
1,330	1,325	80	30002410

Other measurements upon request.

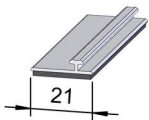

Adapter-T Rail A003, magnetic, transparent

Adapter-T Rail for metal shelves. Can be easily removed for cleaning. (For sheet metal shelves for the fixation of dividers in the back of the shelf.) With black magnetic tape.

Shelf width mm	Length mm	PU	Item No.
600	595	30	30002475
650	645	30	30002476
665	660	30	30002478
900	895	30	30002480
1,000	995	30	30002481
1,250	1,245	30	30002482
1,330	1,325	30	30002483

Other measurements upon request.

System components

Adapter-T Rails

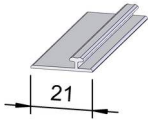

Adapter-T Rail A003, self-adhesive, transparent

Recommended for heavy products. Good bonding to glass, metal and wood shelves. With transparent film adhesive tape.

Shelf width mm	Length mm	PU	Item No.
600	595	50	30002501
650	645	50	30002505
665	660	50	30002507
900	895	50	30002511
1,000	995	50	30002512
1,250	1,245	50	30002516
1,330	1,325	50	30002517

Other measurements upon request.

With lower bend

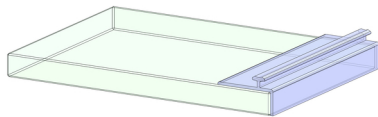

Adapter-T Rails with lower bend 8 mm, for the fixation of System Elements, e.g. dividers and pushfeeds. The lower bend provides **edge protection on glass shelves** as well as **additional strength** of the profile when replenishing the shelving units.

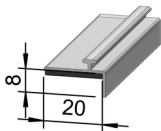

Adapter-T Rail A004, magnetic, transparent

Recommended for heavy products. Can be easily removed for cleaning. With black magnetic tape.

Shelf width mm	Length mm	PU	Item No.
600	595	20	30002524
650	645	20	30002525
665	660	20	30002527
900	895	20	30002528
1,000	995	20	30002529
1,250	1,245	20	30002530
1,330	1,325	20	30002531

Other measurements upon request.

System components

Adapter-T Rails

Adapter-T Rail A002, self-adhesive, transparent

Recommended for light products. Good bonding to glass, metal and wood shelves. With transparent film adhesive tape.

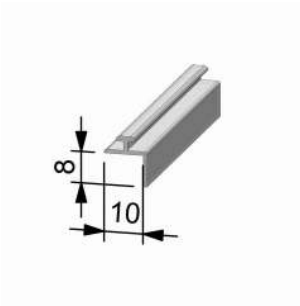

Shelf width mm	Length mm	PU	Item No.
600	595	50	30002417
650	645	50	30002419
665	660	50	30002422
900	895	50	30002425
1,000	995	50	30002426
1,250	1,245	50	30002427
1,330	1,325	50	30002428

Other measurements upon request.

Adapter-T Rail A004, self-adhesive, transparent

Recommended for heavy products. Good bonding to glass, metal and wood shelves. With transparent film adhesive tape.

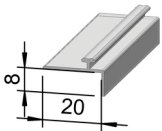

Shelf width mm	Length mm	PU	Item No.
600	595	20	30002534
650	645	20	30002535
665	660	20	30002536
900	895	20	30002537
1,000	995	20	30002538
1,250	1,245	20	30002539
1,330	1,325	20	30002540

Other measurements upon request.

System components

Adapter-T Rails

With upper bend

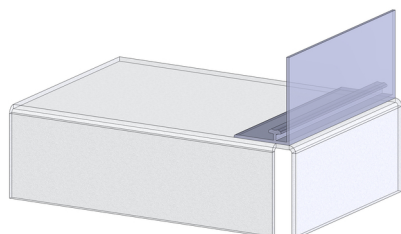

Adapter-T Rails for the fixation of System Elements, e.g. dividers and pushfeeds without front anchor. Also suitable for the use **without pushfeed** – the upper bend serves as front stop.

When using the pushfeeds with front anchor we advise the use of Adapter-T Rails without upper bend.

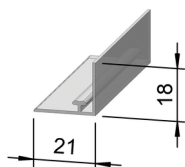

Adapter-T Rail A005, self-adhesive, transparent

Height 18mm. For adhesion on glass, metal and wooden floors. With transparent film adhesive tape.

Shelf width mm	Length mm	PU	Item No.
600	595	20	30002548
650	645	20	30002549
665	660	20	30002550
900	895	20	30002551
1,000	995	20	30002553
1,250	1,245	20	30002554
1,330	1,325	20	30002555

Other measurements upon request.

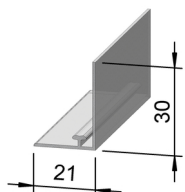

Adapter-T Rail A006, self-adhesive, transparent

Height 30mm. Recommended for tall products. Good bonding to glass, metal and wood shelves. With transparent film adhesive tape.

Shelf width mm	Length mm	PU	Item No.
600	595	20	30002568
650	645	20	30002570
665	660	20	30002571
900	895	20	30002572
1,000	995	20	30002574
1,250	1,245	20	30002575
1,330	1,325	20	30002576

Other measurements upon request.

System components

Adapter-T Rails

Adapter-T Rail A006, magnetic, transparent

Height 30mm. Recommended for high products. Can be easily removed for cleaning. With black magnetic tape.

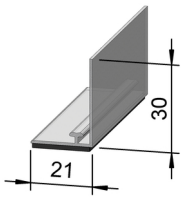

Shelf width mm	Length mm	PU	Item No.
600	595	20	30002559
650	645	20	30002560
665	660	20	30002561
900	895	20	30005150
1,000	995	20	30002563
1,250	1,245	20	30002564
1,330	1,325	20	30002565

Other measurements upon request.

Adapter-T Rail A007, self-adhesive, transparent

Height 40mm. Recommended for high products. Good bonding to glass, metal and wood shelves. With transparent film adhesive tape.

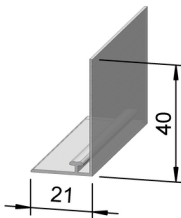

Shelf width mm	Length mm	PU	Item No.
600	595	20	30002591
650	645	20	30002593
665	660	20	30002594
900	895	20	30002595
1,000	995	20	30002597
1,250	1,245	20	30002598
1,330	1,325	20	30002599

Other measurements upon request.

Adapter-T Rail A007, magnetic, transparent

Height 40mm. Recommended for high products. Can be easily removed for cleaning. With black magnetic tape.

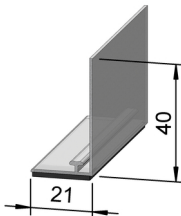

Shelf width mm	Length mm	PU	Item No.
600	595	15	30002581
650	645	15	30002582
665	660	15	30002583
900	895	15	30002584
1,000	995	15	30002585
1,250	1,245	15	30002586
1,330	1,325	15	30002587

Other measurements upon request.

System components

Adapter-T Rails

For shelves with U-Profile

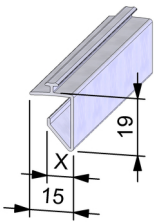
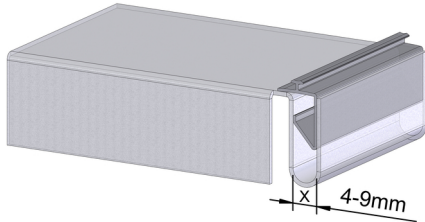

Adapter-T Rails for the fixation of the System Elements, to insert into the **U-Profile** of system shelves, such as Tegometall.

Adapter-T Rail A015, for insertion, transparent

Flexible front gap of 4 to 9mm (x).

Shelf width mm	Length mm	PU	Item No.
600	588	50	30002647
650	638	50	30002648
665	653	50	30002649
900	888	50	30002650
1,000	988	45	30002651
1,250	1,238	45	30002652
1,330	1,318	50	30002654

Other measurements upon request.

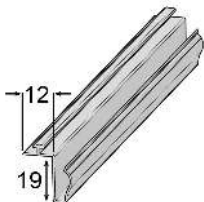

Adapter-T Rail A017, width 19mm, for insertion, transparent

Insertion of 3-4mm front riser.

Shelf width mm	Length mm	PU	Item No.
600	588	50	30010416
650	638	50	30010417
665	653	50	30010418
900	888	50	30010419
1,000	988	45	30010324
1,250	1,238	45	30010325
1,330	1,318	50	30010422

Other measurements upon request.

System components

Adapter-T Rails

With holes for fixation, flat

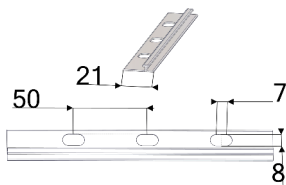
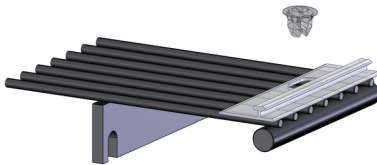

Adapter-T Rails for the fixation of the System Elements, e.g. dividers and pushfeeds, on wire shelves.

Adapter-T Rail A003, to clip on, transparent

Fasteners are included in the delivery for the fixation on the wire shelves. For the fixation of the Adapter-T Rail, the fasteners are clipped through the punched holes onto the wire shelf. Compatible with wire shelves with a diameter of 2,0 to 3,4mm.

Details	Shelf width mm	Length mm	PU	Item No.
with 3 clips	600	590	1	30002604
with 3 clips	665	660	1	30002607
with 4 clips	900	890	1	30002609
with 4 clips	1,000	990	1	30002611
with 5 clips	1,250	1,240	1	30002613
with 5 clips	1,330	1,320	1	30002616

Other measurements upon request.

With advertising insert + retainer for LED-strips

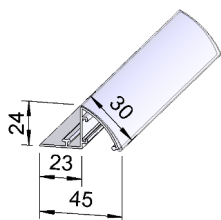
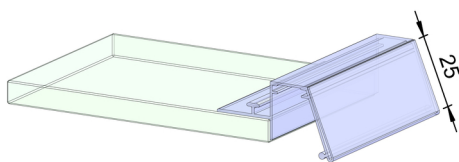

A Shelving System with transparent front for insertion of advertising slides with retainer for LED-strips, suitable for glass, wooden and metal shelves.

Brandline Profile E014 curved, self-adhesive, white

Height 24mm. Adapter-T Rail with transparent front insert for advertising slides H30mm. With retainer for LED-strips. Good bonding to glass, metal and wood shelves. With transparent film adhesive tape.

Shelf width mm	Length mm	PU	Item No.
600	598	20	30003502
650	648	20	30003503
900	898	20	30003504
1,000	998	20	30003505
1,250	1,248	20	30003506

Other measurements upon request.

System components

Adapter-T Rails

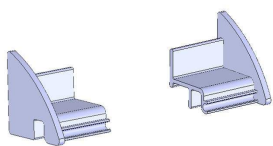

Pair of end caps, white

For lateral insertion into the curved Brandline-Profile E014, incl. fixation on existing Adapter-T Rails.

Dimensions WxDxH mm	PU	Item No.
25x25x20	20	30000053

System components

Divider



Divider, made of plastic with front anchor, to insure order on the shelf unit and the correct functioning of the pushfeeds (avoid the "entanglement" of neighboring products) as well as to safeguard the products' place reservation systems. Available in the heights 35, 60, 100 and 120mm, **also suitable for use in the cooling and freezing sections**. The height of the divider depends on the type of packaging (soft packaging, hard-cover packaging) and the height and form of the product. For fixation on all standard shelving elements, depending on the use, at least one fastener profile (Adapter-T) is needed. Compatible with accessory-elements with rear fixation and grid bar, higher front stops, lighting, and much more. Upon request also available in colour and with individual contour.

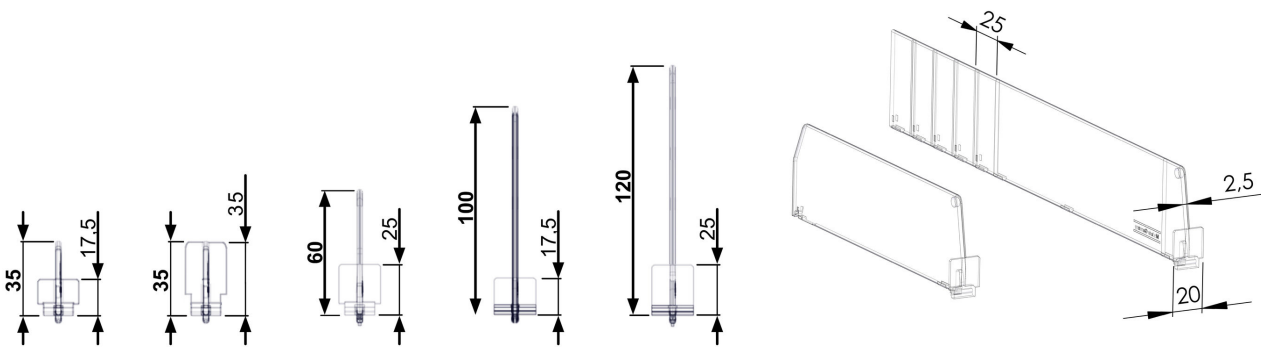

System components

Divider

Height 35mm



Front stop W 20 x H 17,5mm. For the separation of products up to a height of max. 60mm.

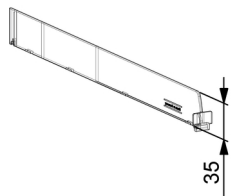

Divider D030, with front fixation, height 35mm, transparent

With 17,5mm front stop.

Length mm	PU	Item No.
105	136	30006164
130	136	30006165
155	136	30003079
180	136	30003080
205	88	30003081
230	88	30003082
255	88	30003083
280	88	30003084
305	68	30003085
330	68	30003086
355	68	30003087
380	68	30003088
405	68	30003089
430	68	30003090
455	68	30003091
480	68	30003092

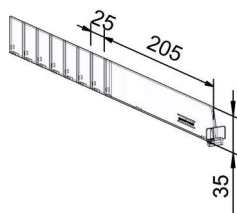

Divider Vario D030, with front fixation, height 35mm, transparent

With variable lengths, can be individually adjusted within 25mm grid. For flexible use of articles with different shelf depths.

Length mm	PU	Item No.
205-355	68	30003115

System components

Divider

Height 35mm



Front stop W 20 x H 35mm. For the separation of products up to a height of max. 100mm.

Divider D030, with front fixation, height 35mm, transparent

With 35mm front stop.

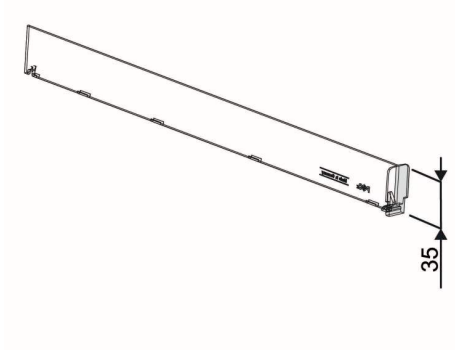

Length mm	PU	Item No.
205	68	30006585
230	68	30006586
255	68	30006587
280	68	30006588
305	52	30006589
330	52	30006590
355	52	30006591
380	52	30006592
405	52	30006593
430	52	30006594
455	52	30006595
480	52	30006596

Divider Vario D030, with front fixation, height 35mm, transparent

With 35mm front stop. With variable lengths, can be individually adjusted within 25mm grid. For flexible use of articles with different shelf depths.

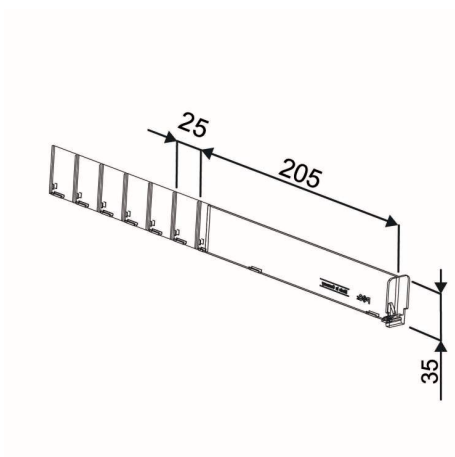

Length mm	PU	Item No.
205-355	52	30006694

System components

Divider

Height 60mm

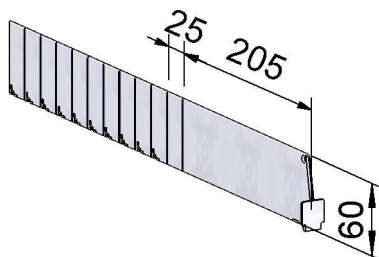

Front stop W 20 x H 25mm. For the separation of products up to a height of max. 120mm.

Divider Vario D060, with front fixation, height 60mm, transparent

With variable lengths, can be individually adjusted within 25mm grid. For flexible use of articles with different shelf depths.

Length mm	PU	Item No.
105-355	68	30011379
205-355	68	30003210
205-480	68	30003211
355-580	68	30003212

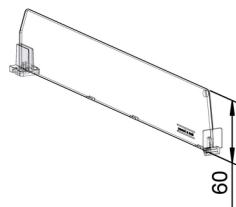

Divider D060, with front and rear fixation, height 60mm, transparent

With fixed lengths and rear divider clamp for the fixation on the Adapter-T Rail.

Length mm	PU	Item No.
180	60	30003159
280	68	30003161
305	44	30003162
330	40	30003163
355	40	30003164
380	33	30003165
405	44	30003166
430	42	30003167
455	42	30003168
480	40	30003169
505	35	30003170
530	35	30003171
555	33	30003172

Other measurements upon request.

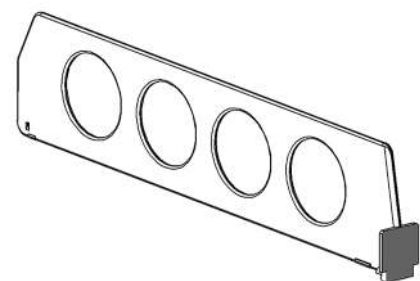

Divider D060 System Techno, with fixation, height 60mm, strap frosted

Surface "strap-frosted". Extremely durable and resistant against scratches, fingerprints and the perception of dust. With front stop W 20 x H 25mm.

Length mm	Height mm	PU	Item No.
230	60	88	30009701
255	60	88	30009702
280	60	88	30009671
305	60	68	30003136
330	60	68	30009703
355	60	68	30009670
380	60	68	30003137
405	60	68	30009704
430	60	68	30009705
455	60	68	30009706
480	60	68	30009707

System components

Divider

Height 100mm

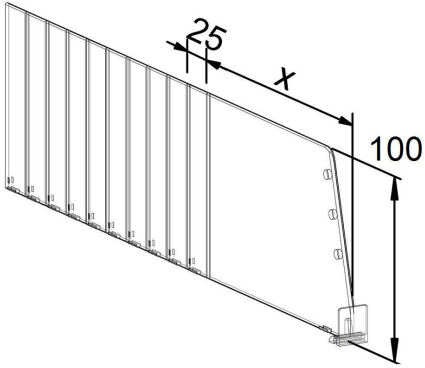

Front stop W 20 x H 17,5mm. For the separation of products up to a height of max. 200mm.

Divider Vario D100, with front fixation, height 100mm, transparent

With variable lengths, can be individually adjusted within 25mm grid. For flexible use of articles with different shelf depths.

Length mm	PU	Item No.
205-355	68	30003238

Height 120mm

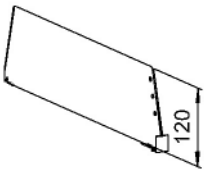

Front stop W 20 x H 25mm. For the separation of products up to a height of max. 240mm.

Divider D120, with front fixation, height 120mm, transparent

Length mm	PU	Item No.
180	136	30003250
205	136	30003251
230	88	30003252
255	88	30003253
280	88	30003254
305	68	30003255
330	68	30003256
355	68	30003257
380	68	30003258
405	68	30003259
430	68	30003260
455	68	30003261
480	68	30003262
505	68	30003263
530	68	30003264
555	68	30003265
580	60	30003266

Divider Vario D120, with front fixation, height 120mm, transparent

With variable lengths, can be individually adjusted within 25mm grid. For flexible use of articles with different shelf depths.

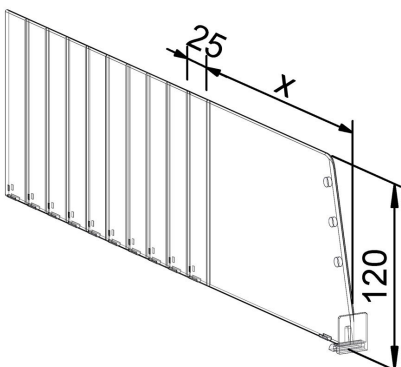

Length mm	PU	Item No.
255-355	68	30003313
255-480	68	30003314
355-580	60	30003315

System components

Divider

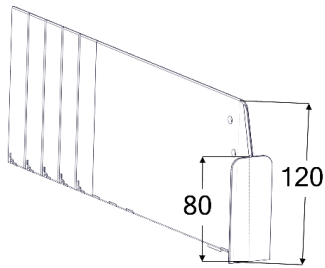

Divider Vario D120, with front fixation and front height 80mm, height 120mm, transparent

For high products with risk of toppling over. With variable lengths, can be individually adjusted within 25mm grid. For flexible use of articles with different shelf depths.

Details	Length mm	PU	Item No.
middle	255-355	26	30003310
middle	255-480	26	30003311
middle	355-580	26	30003312
right	255-355	44	30004921
right	255-480	44	30003301
right	355-580	44	30003302
left	255-355	44	30004920
left	255-480	44	30003303
left	355-580	44	30003304

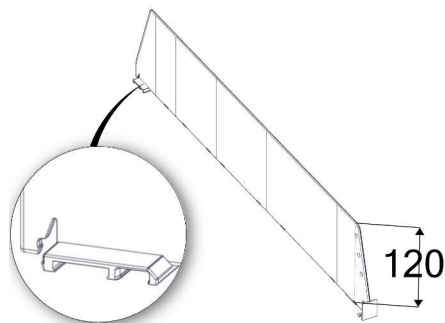

Divider D120, with front and rear fixation, height 120mm, transparent

For the separation of **stacked** as well as **heavy products**.

With fixed lengths and rear-base as integrated part for fixation on Adapter-T Rail.

Length mm	PU	Item No.
330	40	30003271
355	40	30003272
380	40	30003273
405	40	30003274
430	40	30003275
455	40	30003276
480	40	30003277
505	44	30003278
530	40	30003279
555	40	30003280
580	40	30003281

Other measurements upon request.

System components

Divider

Divider D120, with front and rear fixation with magnet, height 120mm, transparent

With fixed length and **magnetic clip** for the rear fixation on metal shelves.

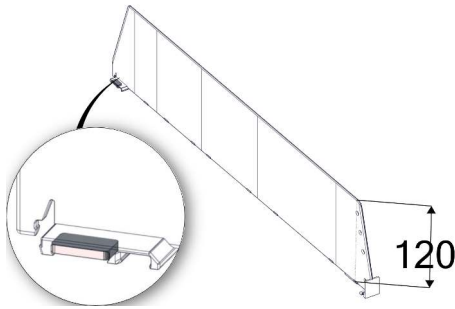

Length mm	PU	Item No.
205	70	30003287
280	70	30003288
305	40	30003289
330	40	30003290
355	40	30003291
380	40	30003292
405	40	30003293
430	40	30003294
455	40	30003295
480	40	30003296
505	44	30003297
530	40	30003298
555	40	30003299
580	33	30003300

Other measurements upon request.

Accessories

Reinforcement elements for divider.

Grid bar A030 for divider, self-adhesive, light gray

For rear fixation and reinforcement of dividers (height 35, 60, 100, 120mm). Good bonding to glass, metal and wood shelves. Prevents the divider from bending when there is a lateral loading with use of pushfeed. With 6mm grid. Height 12mm.

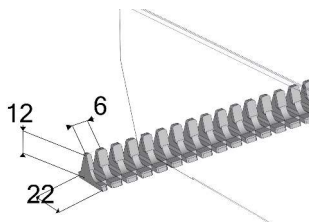

Length mm	Height mm	PU	Item No.
600	12	40	30002700
650	12	40	30002701
660	12	40	30002703
900	12	40	30002706
990	12	40	30002709
1,240	12	40	30002711
1,320	12	40	30002715

Other measurements upon request.

System components

Divider

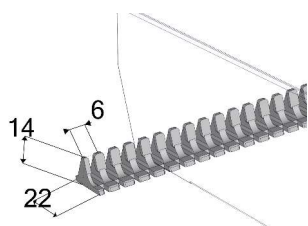

Grid bar A030 for divider, magnetic, light gray

For rear fixation and reinforcement of dividers (height 35, 60, 100, 120mm). Prevents the divider from bending when there is a lateral loading with use of pushfeed. With 6mm grid. Height 14mm.

Length mm	Height mm	PU	Item No.
600	14	40	30002685
650	14	40	30002686
660	14	40	30002687
900	14	40	30002689
990	14	40	30002690
1,240	14	40	30002692
1,320	14	40	30002693

Other measurements upon request.

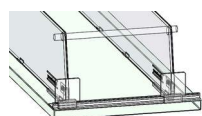

Railing for divider E005, transparent

Additional stop for products at high risk of toppling over. Recommended for example, for **pouches**. Inserted into the holes at the front of the dividers. The railing allows for easy removal. Compatible with divider height 60, 100 and 120mm. Diameter 5mm.

Length mm	Height mm	PU	Item No.
595	5	100	30003438
625	5	100	30003439
655	5	100	30003441
685	5	100	30003442
895	5	100	30003443
995	5	100	30003444
1,245	5	100	30003445
1,325	5	100	30003446

Other measurements upon request.



End cap for railing, black

For the fixation of railings.

Length mm	Height mm	PU	Item No.
14	11	1,000	10000338

Connector for railing, transparent

To connect two railings. Diameter 8mm.

Length mm	PU	Item No.
50	50	30000321



System components

Guiderails

For the reduction of the friction between the product and the shelving unit. Necessary for guidance of the pushfeed, except for very light, square packagings.

With the following advantages:

- Improved gliding properties when pushing the merchandise
- Less effort needed when replenishing the shelf
- Less friction - thus, more safety for the products and protection of the product packaging

Guiderails width 19mm

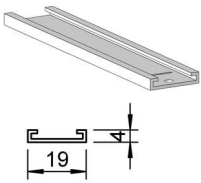

Guiderail F001, for Pushfeed with width 15mm, light gray

Width 19mm with end stop, recommended length is 20mm shorter than the divider. The F001 is oiled.

Length mm	PU	Item No.
185	350	30003756
210	350	30003758
235	350	30003761
260	350	30003763
285	300	30003765
310	250	30003766
335	250	30003768
365	250	30003770

Other measurements upon request.

Guiderails width 34mm

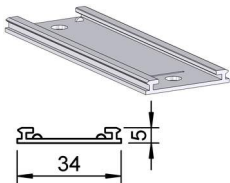

Guiderail F003, for Pushfeeds with width 28, 40, 44 and 75mm, light gray

Width 34mm, with end stop. The F003 is oiled.

Length mm	PU	Item No.
245	100	30003927
345	100	30003937
445	100	30003945
183	100	30003921
208	100	30003923
233	100	30003924
258	100	30003928
283	100	30003931
308	100	30003933
333	100	30003935
358	100	30003938
383	100	30003940
408	100	30003943
433	100	30003944
458	100	30003946
483	100	30003947
508	100	30003948
533	100	30003950
558	100	30003951

Other measurements upon request.

System components

Guiderails

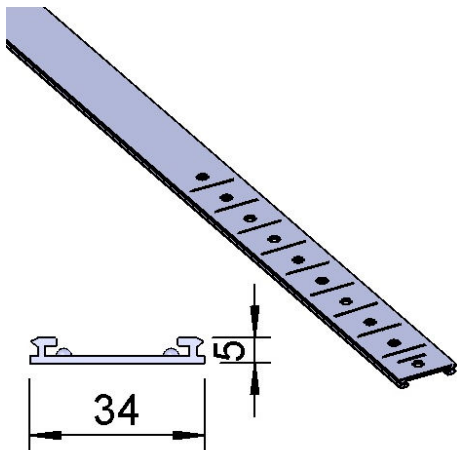

Guiderail Vario F003, for Pushfeeds with width 28, 40, 44 and 75mm, light gray

Width 34mm, with end stop, recommended length is 22mm shorter than the divider. Snap-off units every 25mm. Breakable increments guarantee a simple and efficient handling during assembly. For use with pushfeeds that have a raised bottom housing only. The F003 is oiled.

Length mm	PU	Item No.
183-333	100	30003984
233-458	100	30003985
333-558	100	30003986

Other measurements upon request.

System components

Complete shelf equipment

Presentation solution for **cigarettes** (king size, big pack, maxi pack, etc.), **pouches** and **cigarillos** consisting of the Pushfeed- and Divider-System, fitting all standard shelves.

Without Adapter-T Rail (see chapter Adapter-T Rail).

Shelf equipment for RMC

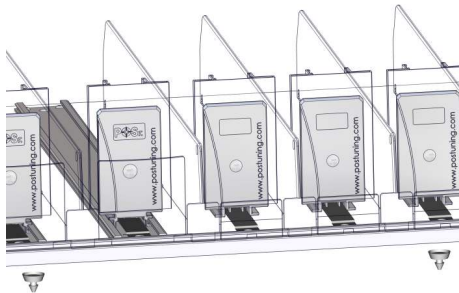

Complete Glass Shelves

Presentation solution for cigarettes and pouches, consisting of:

- Glass shelves
- Rubber layer for glass shelves
- Adapter-T Rail
- Divider
- Pushfeed 2N with labelholder
- Pushfeed 4-8N with labelholder
- Guiderail

without brackets

Assembly kit for individual shelves

No. of Facings	Depth mm	Width mm	PU	Item No.
10	380	600	1	30000855
11	380	650	1	30000856
13	380	900	1	30000858
15	380	1,000	1	30000852
19	380	1,250	1	30000853

Brackets for glass shelves, silver

Made of 2mm steel sheet. With holes for fitting of glass shelves with rubber stoppers. Compatible with all shelving systems.

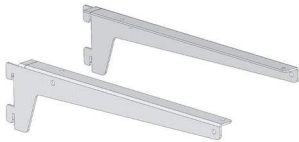

Depth mm	Hole pitch mm	PU	Item No.
320	30/60	20	70000141
320	35/70	20	70000142
320	40/42	20	70000144
320	45	20	70000148
320	50	20	70000152

Cigarettes

Presentation solution for cigarettes, consisting of:

- Divider
 - Pushfeed
- without** Adapter-T Rails

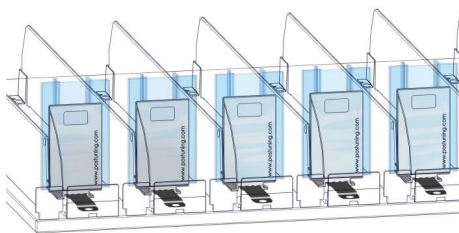

Assembly kit for individual shelves

No. of Facings	Depth mm	Width mm	PU	Item No.
10	355	600	1	30003063
11	355	650	1	30003064
13	355	900	1	30003065
15	355	1,000	1	30003061
19	355	1,250	1	30003062

Suitable Adapter-T Rails for each type of shelf can be found in chapter Shelf Management Systems / Mounting System.

System components

Complete shelf equipment

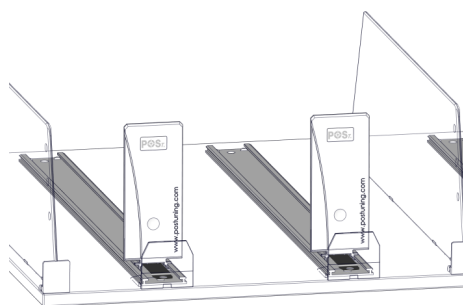

Cigarette cartons

Presentation solution for cigarette cartons, consisting of:

- Divider
- Pushfeed
- Guiderail

without Adapter-T Rails

Assembly kit for individual shelves

No. of Facings	Depth mm	Width mm	PU	Item No.
2	355	600	1	30003078
3	355	900	1	30004891
4	355	1,250	1	30004890

Suitable Adapter-T Rails for each type of shelf can be found in chapter Shelf Management Systems / Mounting System.

Shelf equipment for Pouches

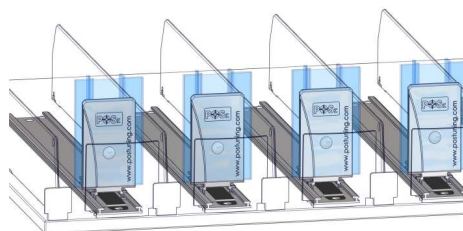

Pouches

Presentation solution for pouches, consisting of:

- Divider
- Pushfeed
- Guiderail

without Adapter-T Rails

Assembly kit for individual shelves

No. of Facings	Depth mm	Width mm	PU	Item No.
6	355	600	1	30003076
7	355	650	1	30004888
10	355	900	1	30003077
11	355	1,000	1	30003074
14	355	1,250	1	30003075

Suitable Adapter-T Rails for each type of shelf can be found in chapter POS-T Shelf Management Systems / Mounting System.

Shelf equipment for Cigarillos



Cigarillos and e-cigarettes

Presentation solution for cigarillos and e-cigarettes, consisting of:

- Divider
- Pushfeed

without Adapter-T Rails

Assembly kit for individual shelves

No. of Facings	Depth mm	Width mm	PU	Item No.
9	355	600	1	30003068
12	355	900	1	30003069
13	355	1,000	1	30003066
16	355	1,250	1	30003067

System components

Flexible shelf equipment

For small nicotine products



Assembly kit small

Presentation solution for disposable e-cigarettes, e-shishas, liquids and other narrow products, consisting of:

- Adapter-T Rail (2 x 498mm length)
- Vario divider
- Pushfeed

No. of Facings	Length mm	Width mm	PU	Item No.
26	205-355	996	1	30010926

For medium nicotine products



Assembly kit medium

Presentation solution for cigarettes, shisha tobacco, wide liquid pods and tobacco tins, consisting of:

- Adapter-T Rail (2 x 498mm length)
- Vario divider
- Pushfeed

No. of Facings	Length mm	Width mm	PU	Item No.
16	205-355	996	1	30010927

For big nicotine products



Assembly kit big

Presentation solution for roll-your-own tobacco, e-cigarettes (devices) and other heavy products, consisting of:

- Adapter-T Rail (2 x 498 mm length)
- Vario divider
- Pushfeed

No. of Facings	Length mm	Width mm	PU	Item No.
16	205-355	996	1	30010928